

LDT33 Series

Affordable Steel Articulating Monitor Arms

For most 17"-32" monitors

The LDT33 Series monitor arms provide the user with proper ergonomic viewing with both function and affordability.



LDT33 Series
Overview Video

LDT33 Series

Affordable Steel Articulating Monitor Arms

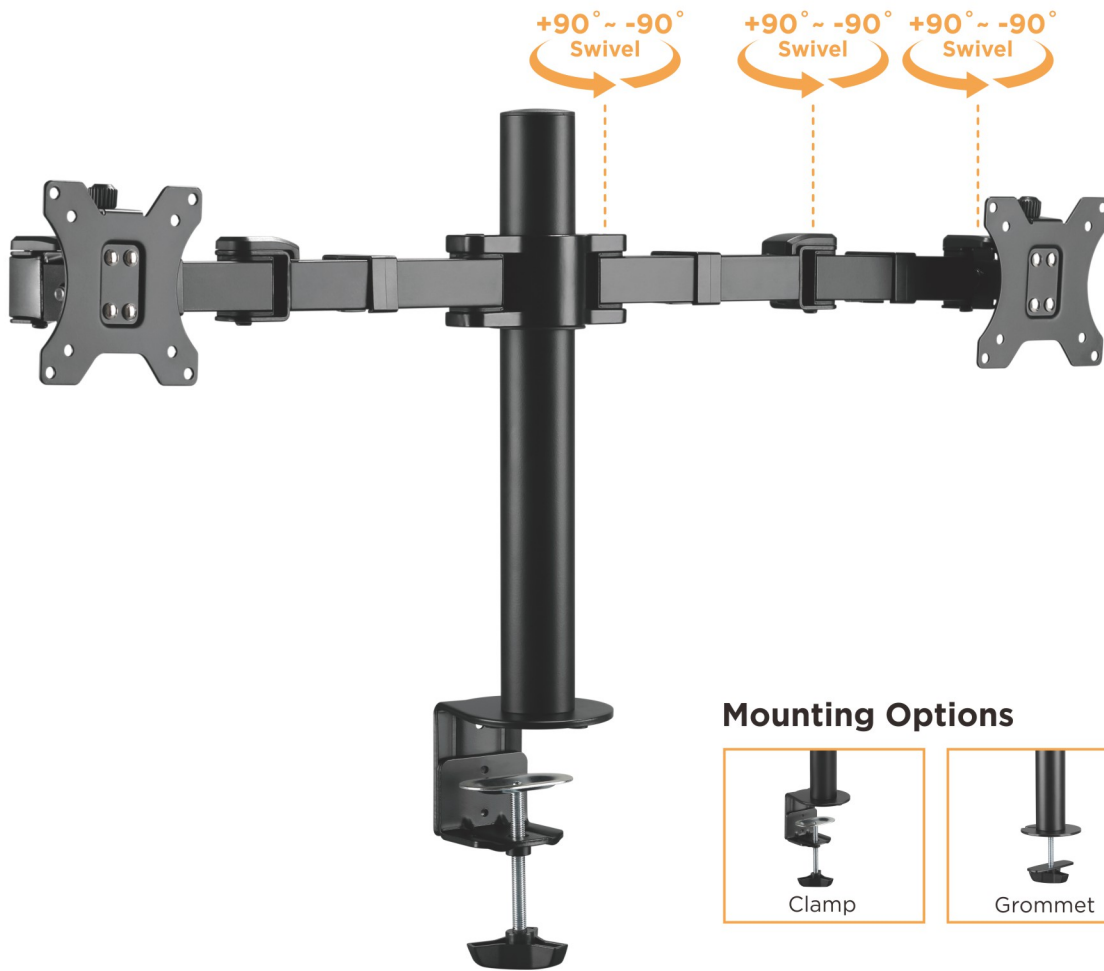

Mounting Options



Clamp



Grommet



Freestanding



Detachable VESA Plate
for quick and easy installation



Freely Tilting Design
for your desired viewing angle

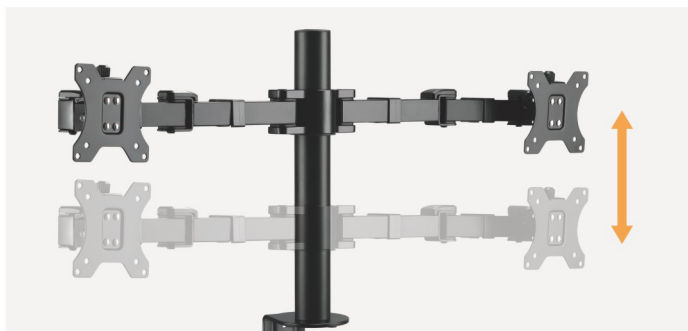

Adjustable Height
provides optimal ergonomic viewing

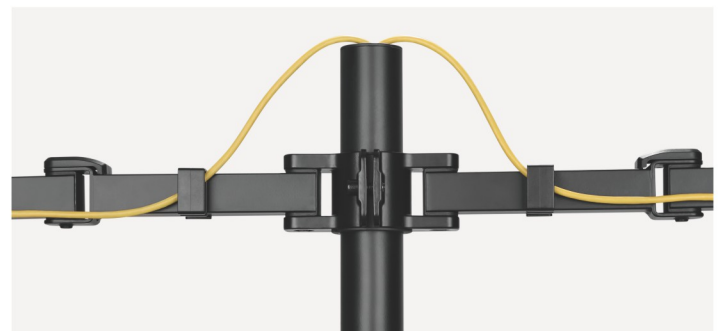

Cable Management
keeps things organized and clean

LDT33 Series

Affordable Steel Articulating Monitor Arms



LDT33-C01 For Single Monitor

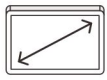

Screen Size
17"-32"

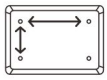

VESA Compatible
75x75 100x100



Weight Capacity
12kg/26.4lbs



Screen Rotation
+180°--180°



Tilt Range
+35° - -35°

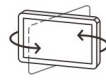

Swivel Range
+90° - -90°

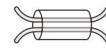

Cable Management

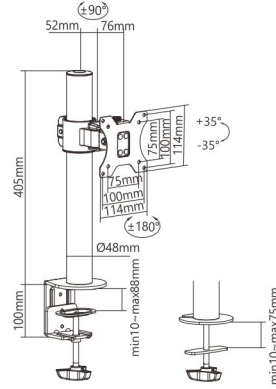

LDT33-C011 For Single Monitor

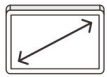

Screen Size
17"-32"

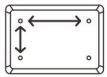

VESA Compatible
75x75 100x100



Weight Capacity
12kg/26.4lbs



Screen Rotation
+180°--180°



Tilt Range
+35° - -35°

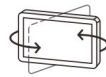

Swivel Range
+90° - -90°

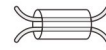

Cable Management

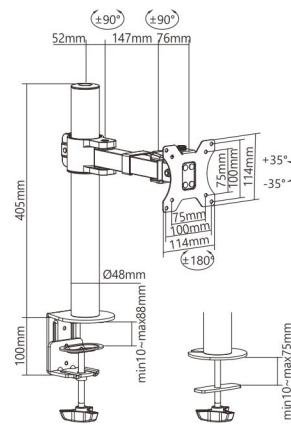

LDT33-C012 For Single Monitor

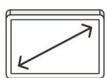

Screen Size
17"-32"

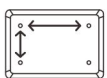

VESA Compatible
75x75 100x100



Weight Capacity
12kg/26.4lbs



Screen Rotation
+180°--180°



Tilt Range
+35° - -35°

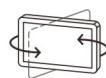

Swivel Range
+90° - -90°

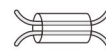

Cable Management

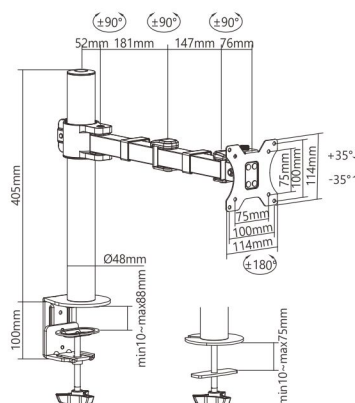

LDT33 Series

Affordable Steel Articulating Monitor Arms



LDT33-C024 For Dual Monitors

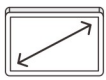

Screen Size
17"-32"

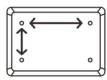

VESA Compatible
75x75 100x100



Weight Capacity
12kg/26.4lbs(x2)



Screen Rotation
+180°--180°



Tilt Range
+35° - -35°

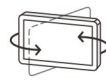

Swivel Range
+90° - -90°

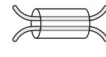

Cable Management

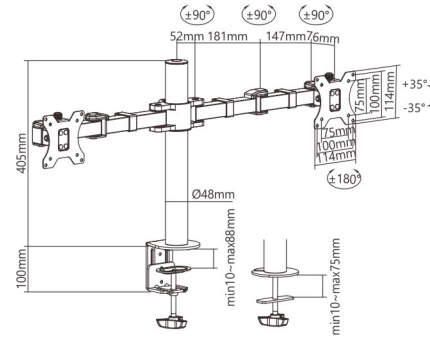
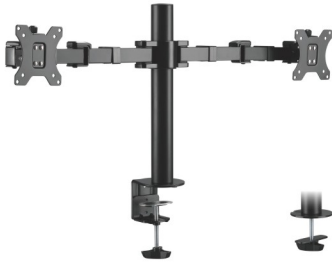

LDT33-C036 For Triple Monitors

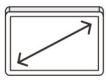

Screen Size
17"-27"

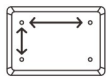

VESA Compatible
75x75 100x100



Weight Capacity
8kg/17.6lbs (x3)

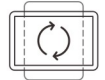

Screen Rotation
+180°--180°



Tilt Range
+25° - -25°

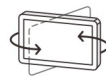

Swivel Range
+90° - -90°

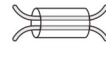

Cable Management

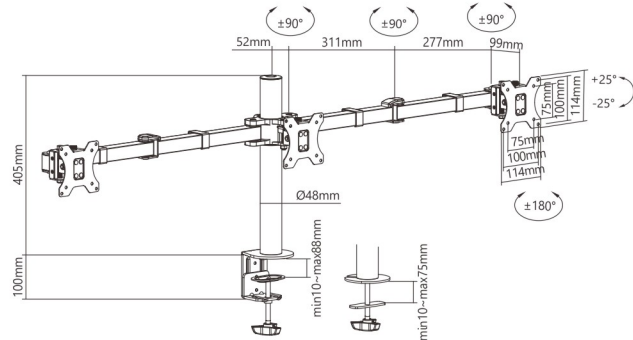

LDT33-C048 For Quad Monitors

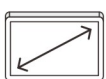

Screen Size
17"-32"

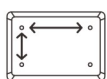

VESA Compatible
75x75 100x100



Weight Capacity
12kg/26.4lbs(x4)

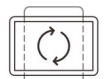

Screen Rotation
+180°--180°



Tilt Range
+35° - -35°

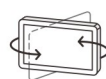

Swivel Range
+90° - -90°

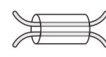

Cable Management

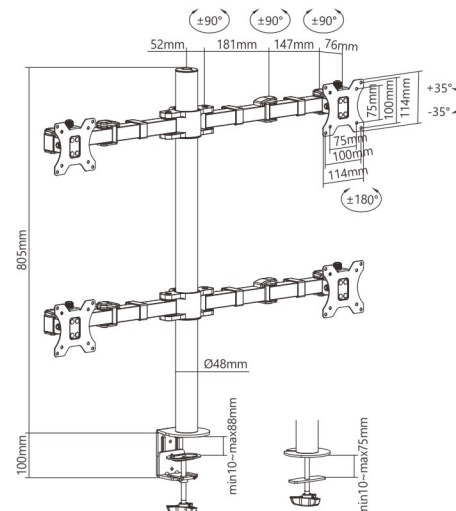

LDT33 Series

Affordable Steel Articulating Monitor Arms



LDT33-T01 For Single Monitor

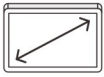

Screen Size
17"-32"

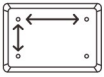

VESA Compatible
75x75 100x100



Weight Capacity
12kg/26.4lbs



Screen Rotation
+180°--180°



Tilt Range
+35° ~ -35°

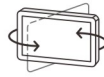

Swivel Range
+90° ~ -90°

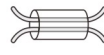

Cable Management

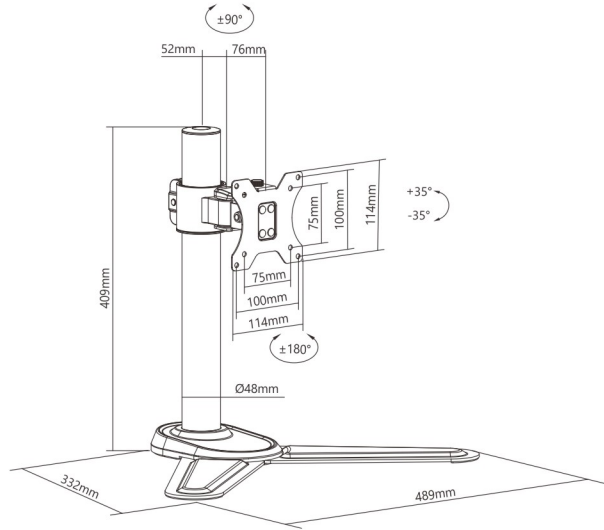

LDT33-T024 For Dual Monitors

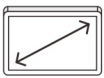

Screen Size
17"-32"

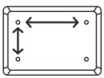

VESA Compatible
75x75 100x100



Weight Capacity
12kg/26.4lbs(x2)



Screen Rotation
+180°--180°



Tilt Range
+35° ~ -35°

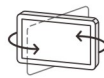

Swivel Range
+90° ~ -90°

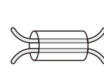

Cable Management

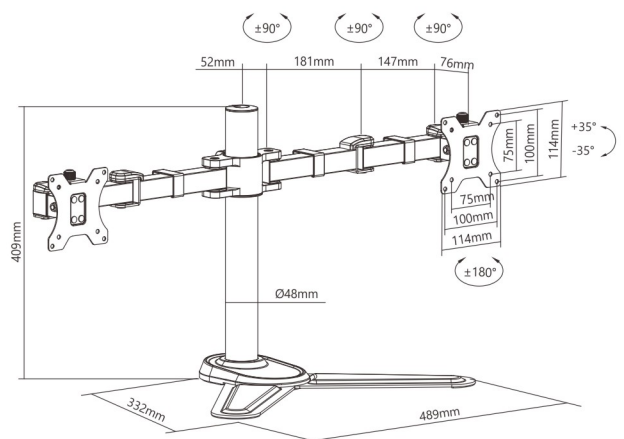

LDT33 Series

Affordable Steel Articulating Monitor Arms



LDT33-T036

For Triple Monitors

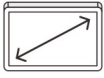

Screen Size
13"-27"

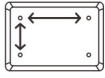

VESA Compatible
75x75 100x100



Weight Capacity
8kg/17.6lbs (x3)



Screen Rotation
+180°--180°



Tilt Range
+25° - -25°

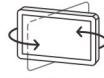

Swivel Range
+90° - -90°

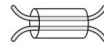

Cable
Management

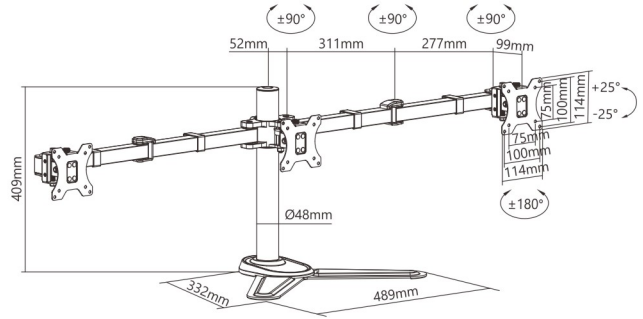

LDT33-T048

For Quad Monitors

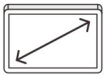

Screen Size
17"-32"

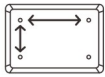

VESA Compatible
75x75 100x100



Weight Capacity
12kg/26.4lbs(x4)



Screen Rotation
+180°--180°



Tilt Range
+35° - -35°

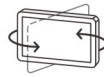

Swivel Range
+90° - -90°

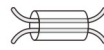

Cable
Management

