

Ci5160RLM-THX Architectural Speaker

Now with Metamaterial Absorption Technology

Since 1961, KEF has been dedicated to faithfully reproducing sound in its purest form – just as the artist intended. Decades of experience in acoustic innovation on our quest for music perfection now combine in the Ci-R Series: delivering sound with unrivalled detail and depth that consistently sparks excitement with every encounter.

Ci-R series speakers are built to the same exacting standards as R Series, which is a direct beneficiary of the technological innovations developed for The Reference, the class-leading series that continually set the benchmark for loudspeakers and sound reproduction.

The Ci5160RLM-THX architectural speaker from the KEF Extreme Home Theatre range is a case in point. Incorporating a 12th generation Uni-Q driver array it features KEF's groundbreaking Metamaterial Absorption Technology (MAT), refined to maximise its full potential, and proudly carries the THX Certified Ultra designation - one of the highest THX[®] performance classes. This fusion of cutting-edge engineering, design and precision craftsmanship delivers every nuance, whisper, and sonic explosion with astonishing clarity and impact, in large home theatres and living rooms alike.

12th generation Uni-Q driver array with MAT

At the heart of Ci5160RLM-THX sits the latest example of KEF's signature driver array - Uni-Q. Now in its 12th generation, this remarkable feat of engineering acts as a point source, dispersing sound more evenly allowing everyone to experience the same natural detailed sound, wherever in the room they are.

The Ci5160RLM-THX also benefits from another groundbreaking acoustic innovation: Metamaterial Absorption Technology (MAT). MAT is a highly complex maze-like structure that absorbs 99% of the unwanted sound from the rear of the tweeter, delivering a crisper, more natural treble performance.

Powerful, room-filling high-fidelity sound

Bass is a vital element of performance. The four bass drivers in Ci5160RLM-THX have a two-part structure with a shallow, concave, aluminium skin over a paper cone. This stiffness, combined with the cone's unique geometry, achieves a piston-like movement for punch and speed. The drivers' motor system creates a broad and uniform magnetic field, delivering impressive and impactful bass at any volume.

To enhance performance further, fully rebalanced crossovers have been implemented to achieve superior on and off-axis frequency response. The Ci5160RLM-THX carries the prestigious THX[®] Certified Ultra designation, having undergone rigorous tests in output levels, frequency response, signal-to-noise ratio and distortion, ensuring it recreates high-impact cinema sound and best-in-class audio fidelity.

The result is breathtaking – realistic, immersive sound for remarkably dynamic music, gaming, TV, and movies.

Total attention to detail

Ci5160RLM-THX is designed to be both acoustically and visually exceptional, meticulously refined and engineered to KEF's unparalleled standards.

The 5.5mm thick, precision-machined aluminium baffle of Ci5160RLM-THX is not only a mark of quality and aesthetic excellence, but also eliminates vibration and provides a stoic platform for the drivers to perform at their best.

Hide your speakers, not your sound

'Hide your speakers, not your sound' is the concept behind KEF's comprehensive range of architectural speakers. Ci5160RLM-THX is engineered with best-in-class acoustic performance and designed to be discreet in appearance with its paintable magnetic metal grille, delivering an immersive soundscape via speakers that blend into the interior design. Available in Aluminium Silver, including tone matched Uni-Q and bass drivers. A black cloth magnetic grille is also available as an accessory.



Summary of features

- Metamaterial Absorption Technology eliminates 99% of high-frequency distortion for pure, natural sound
- 12th generation Uni-Q with MAT driver array for exceptional acoustic accuracy
- Four hybrid aluminium bass drivers for tight, deep, controlled bass
- THX[®] Certified Ultra for high impact cinema sound
- Discreet design allows for easy blending into the room
- Available in Aluminium Silver
- Paintable magnetic metal grille that fits effortlessly into the interior
- Optional black cloth grille available



Specifications

Model	Ci5160RLM-THX	
Series	Ci-R Series	
Nominal impedance	4Ω	
Sensitivity (2.83V/1m)	89dB	
Frequency response (±6dB) open-backed	40Hz - 28kHz	
Frequency range (-10dB)	32Hz - 45kHz	
Nominal coverage (degrees)	150°	
Max SPL (dB)	110dB	
Crossover frequency	640Hz, 2.6kHz	
Drive units	LF	4 x 160mm (6.5in.)
	MF	160mm (6.5in.) Uni-Q
	HF	25mm (1in.) vented aluminium dome with Metamaterial Absorption Technology ¹
Recommended amplifier power	50 - 350W	
Recommended high-pass filter (Hz)	35 - 80Hz	
Product external dimensions (H x W x D)	1070 x 230 x 105.7 mm (42.13 x 9.06 x 4.16 in.)	
Cut-out dimensions (H x W)	1052 x 209 mm (41.42 x 8.23 in.)	
Net Weight	18.7 kg (41.1 lbs.)	
Mounting depth from surface	99mm (3.9in.)	
Optional rough in frame	RIF5160L	
Ideal rear volume	90L	
Minimum rear volume	40L	
THX certification	THX [®] Certified Ultra	
Safety and Regulatory Compliance	NA	
Wall thickness (Maximum)	40mm (1.58in.)	
Wall thickness (Minimum)	6mm (0.24in.)	



¹ Metamaterial Absorption Technology is a joint development with Acoustic Metamaterials Group.

Visit [KEF.COM](https://www.kef.com) for more about KEF and its products.

KEF reserves the right, in line with continuing research and development, to amend or change specifications. E&OE. The Ci speakers that utilise THX in the model name have undergone and passed THX Certified approval.

Directivity Index

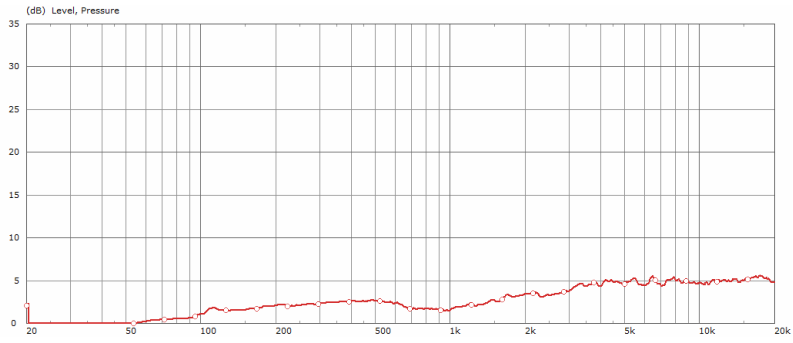

Beamwidth -3dB

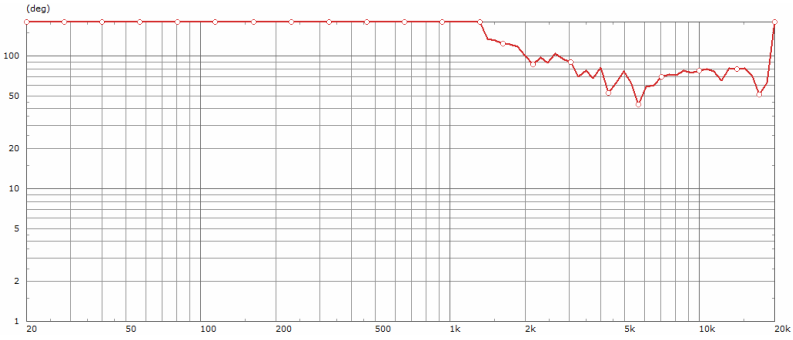

Beamwidth -6dB

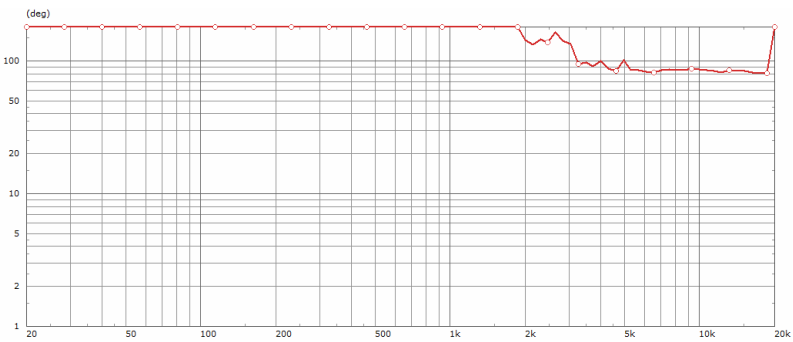

Impedance

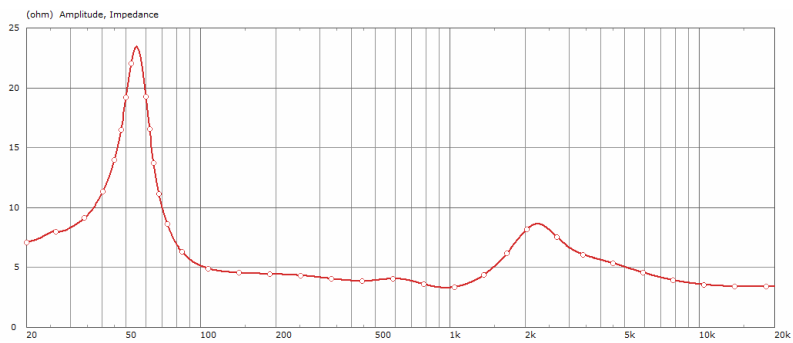

Sensitivity (2.83V/1m)

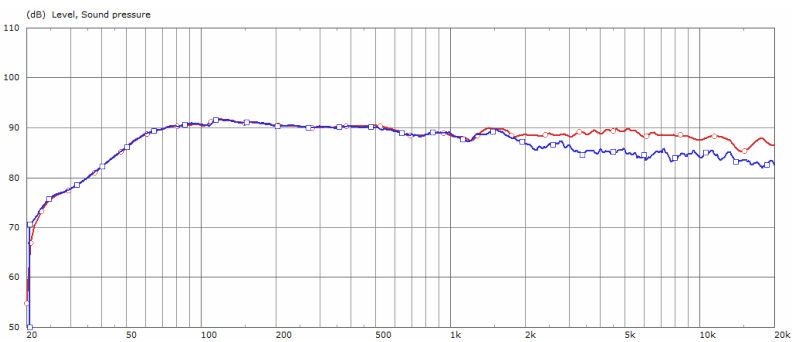

Polar Responses

Polar 63Hz

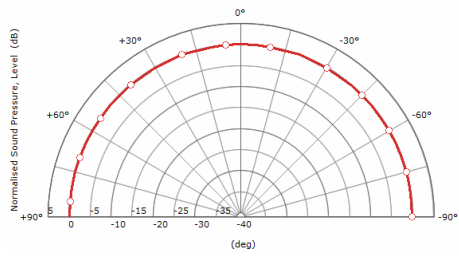

Polar 125Hz

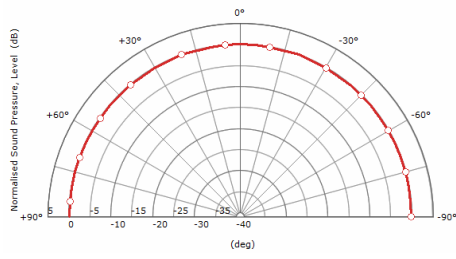

Polar 250Hz

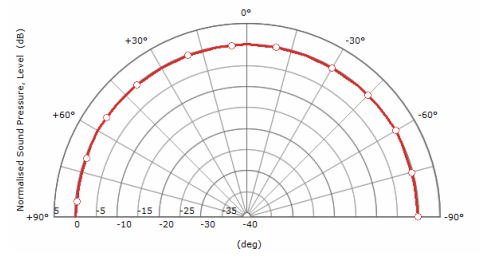

Polar 500Hz

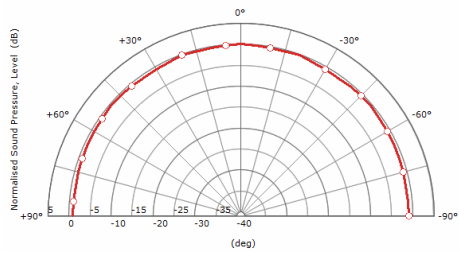

Polar 1kHz

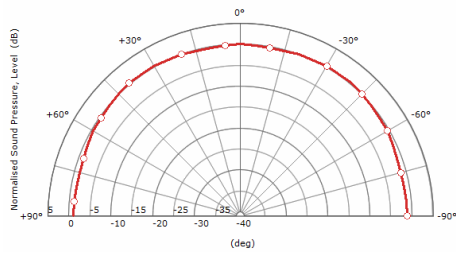

Polar 2kHz

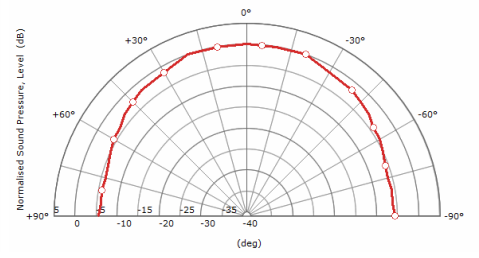

Polar 4kHz

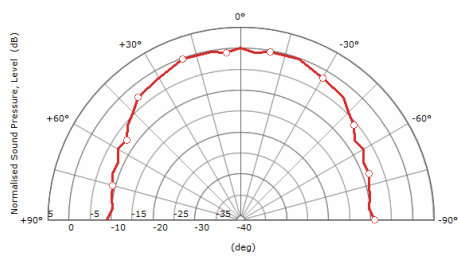

Polar 8kHz

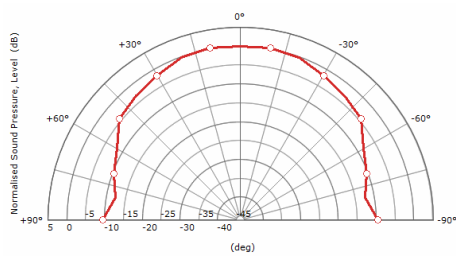

Polar 16kHz

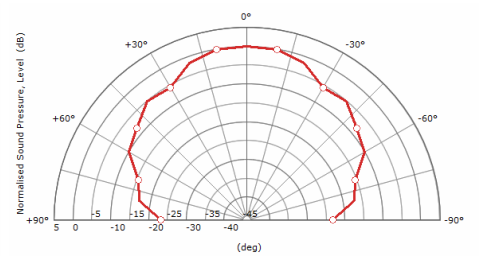

Mechanical Diagrams

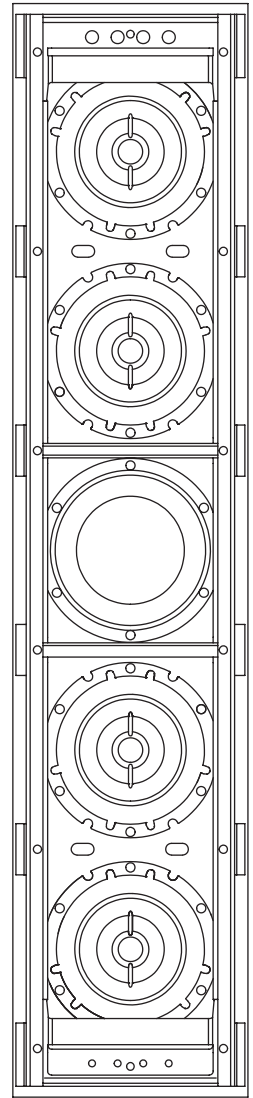
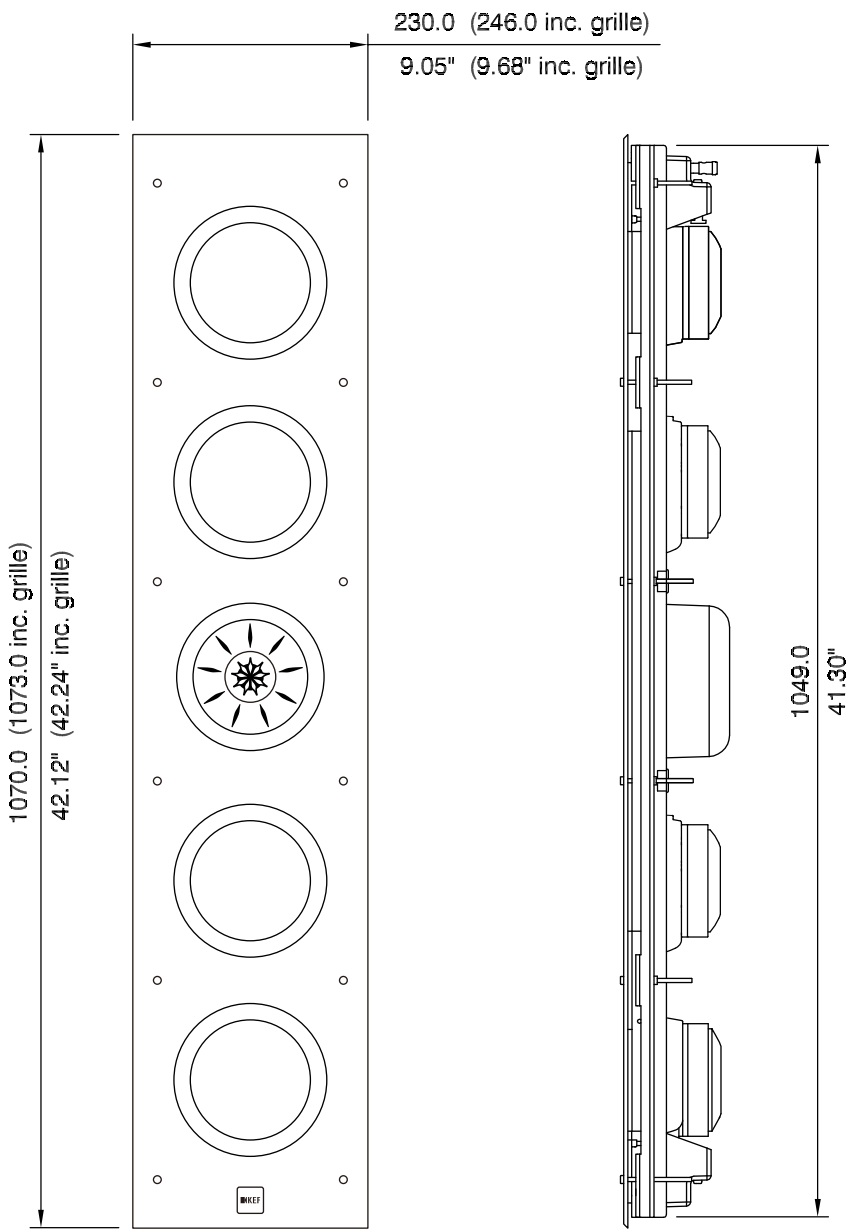
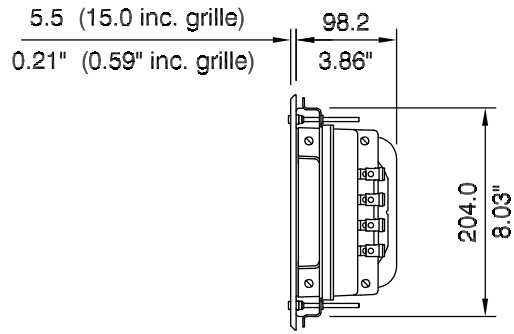

Dimensions in mm (inches)

KEF reserves the right, in line with continuing research and development, to amend or change specifications. E&OE.