

C3N Outdoor Smart Wi-Fi Camera

Security Video For Smart Life

2019.11



01

02

03

04

Introduction

Features

Operation

FAQ

01

Introduction



Package Contents

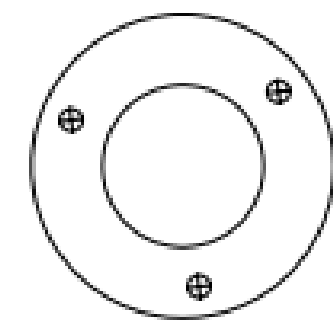
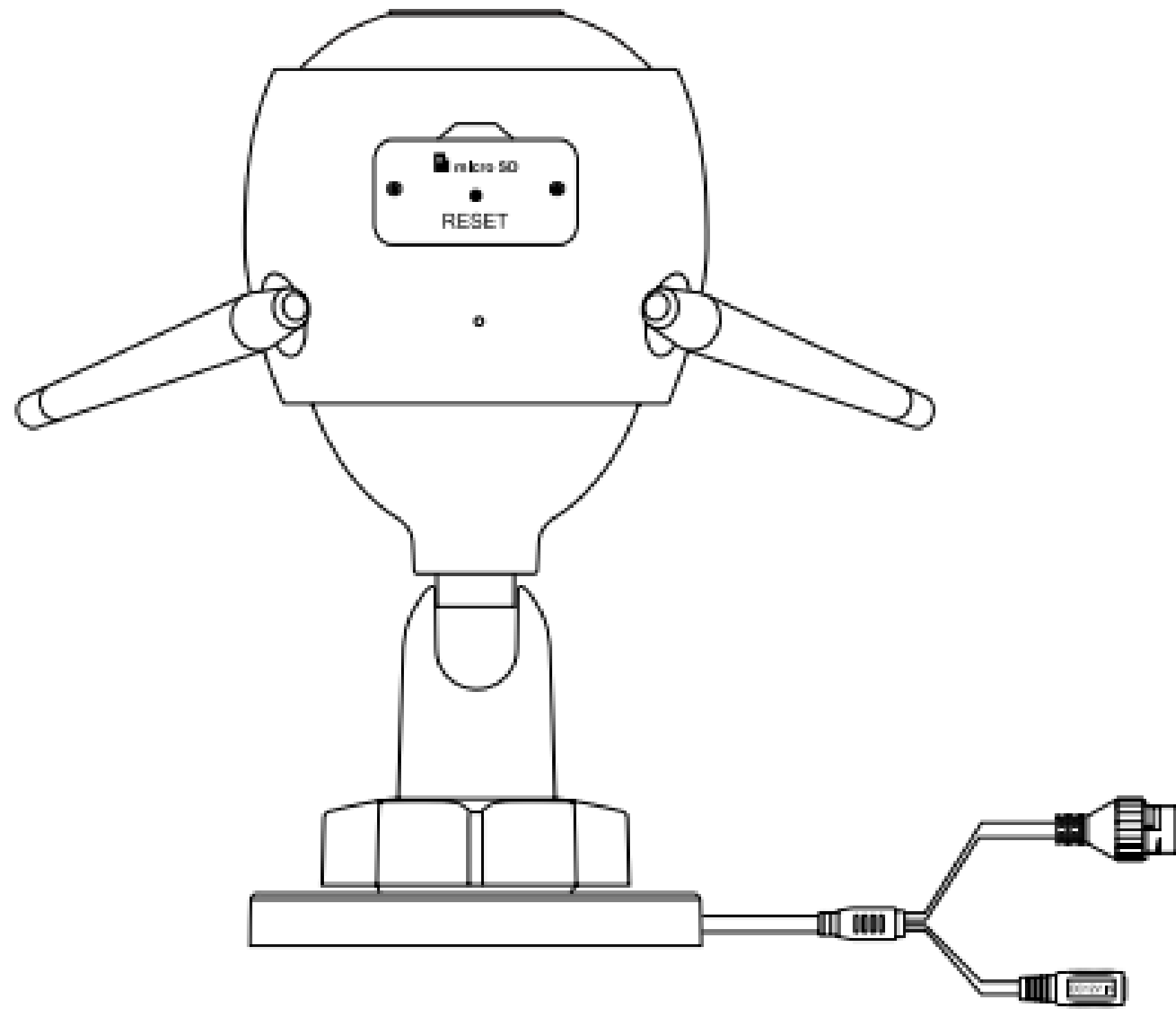

Drill Template

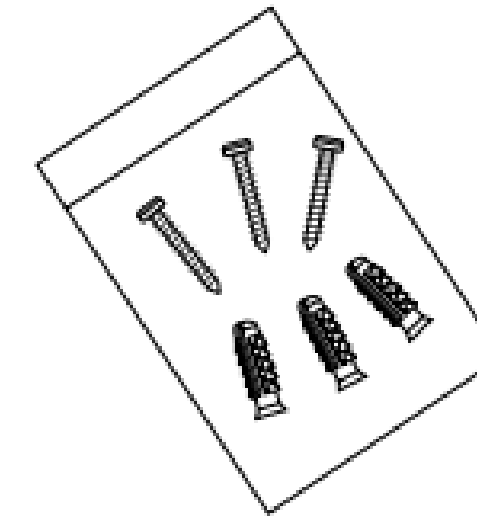

Screw Kit

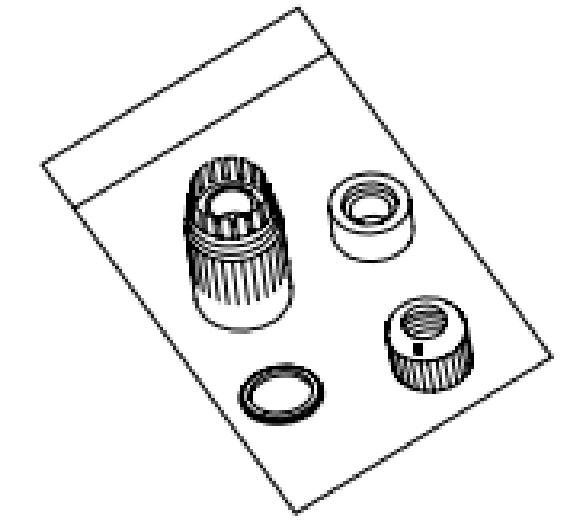

Waterproof Kit

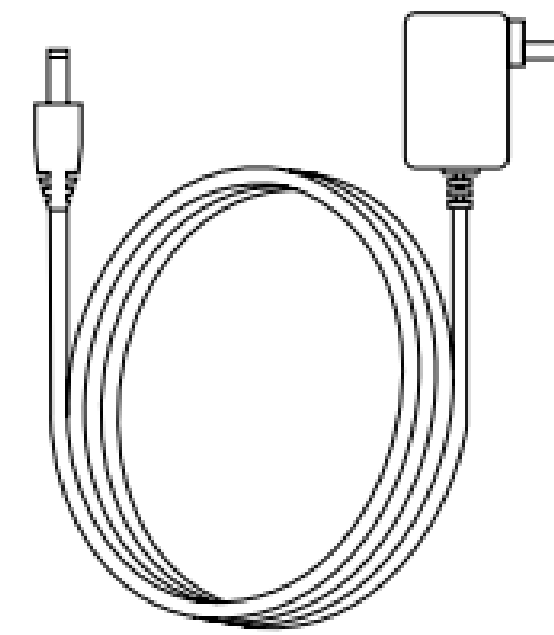

Power Adapter

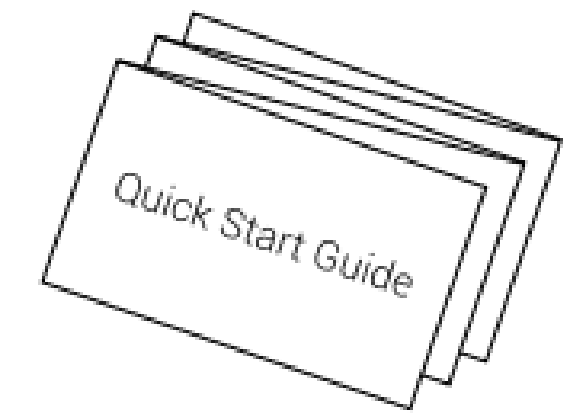

Quick Start Guide

Appearance

CS-C3N-A0-3H2WFRL



Appearance

75.5mm × 75.5mm × 155mm

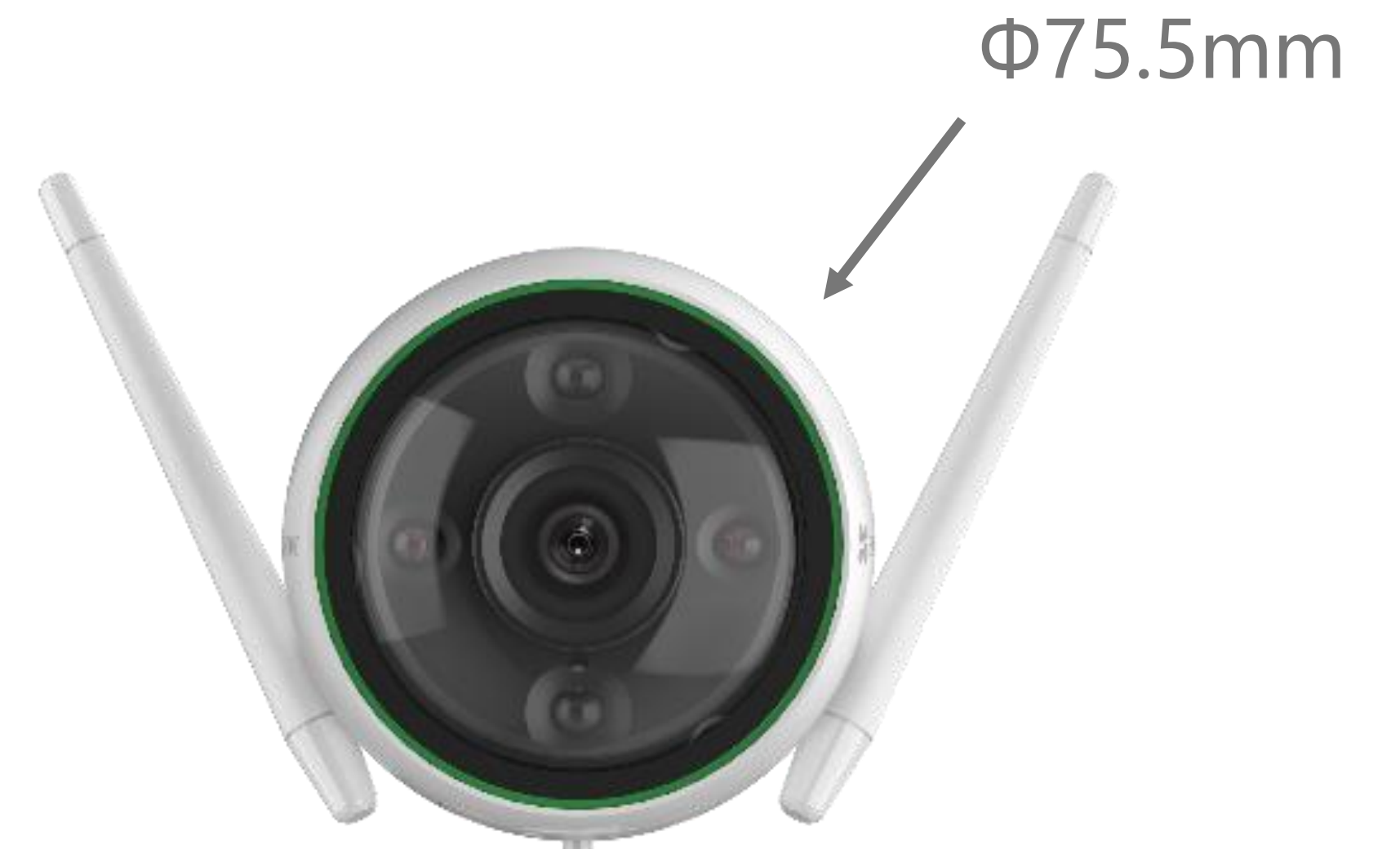
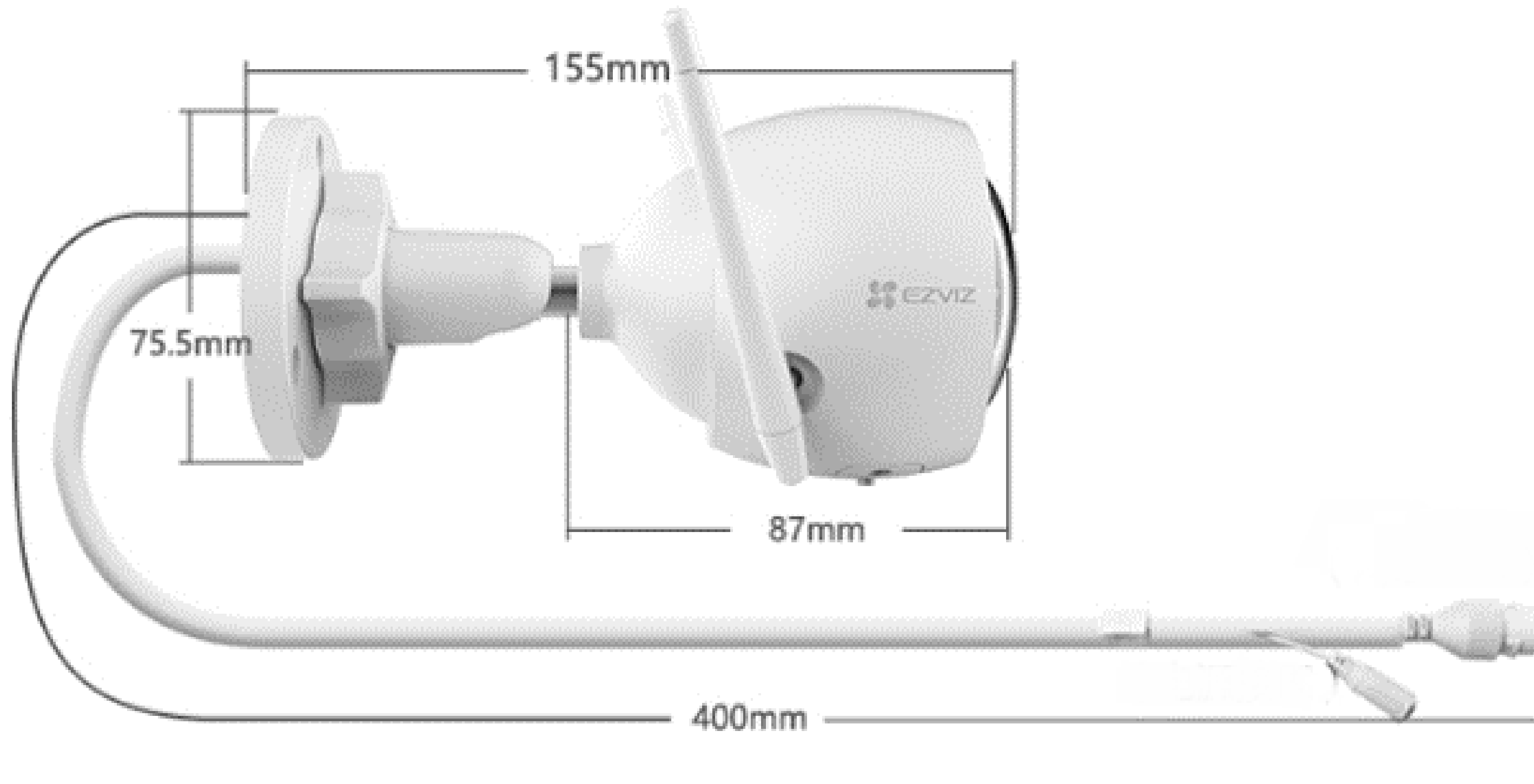

Appearance

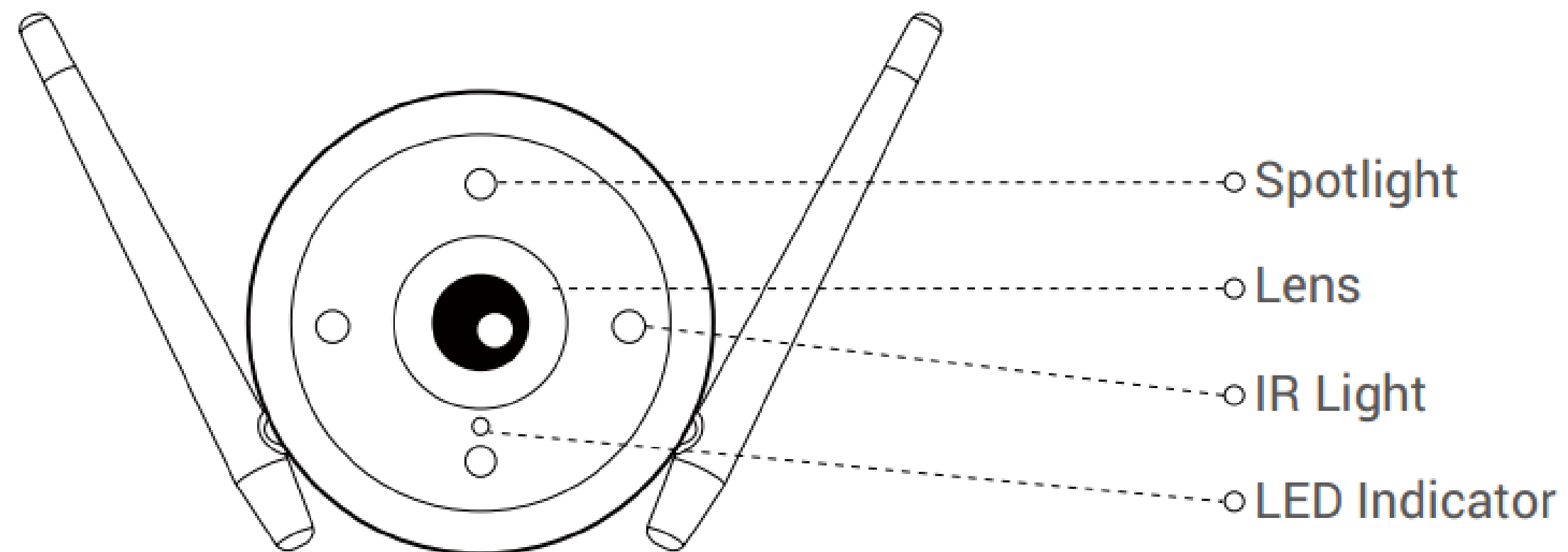
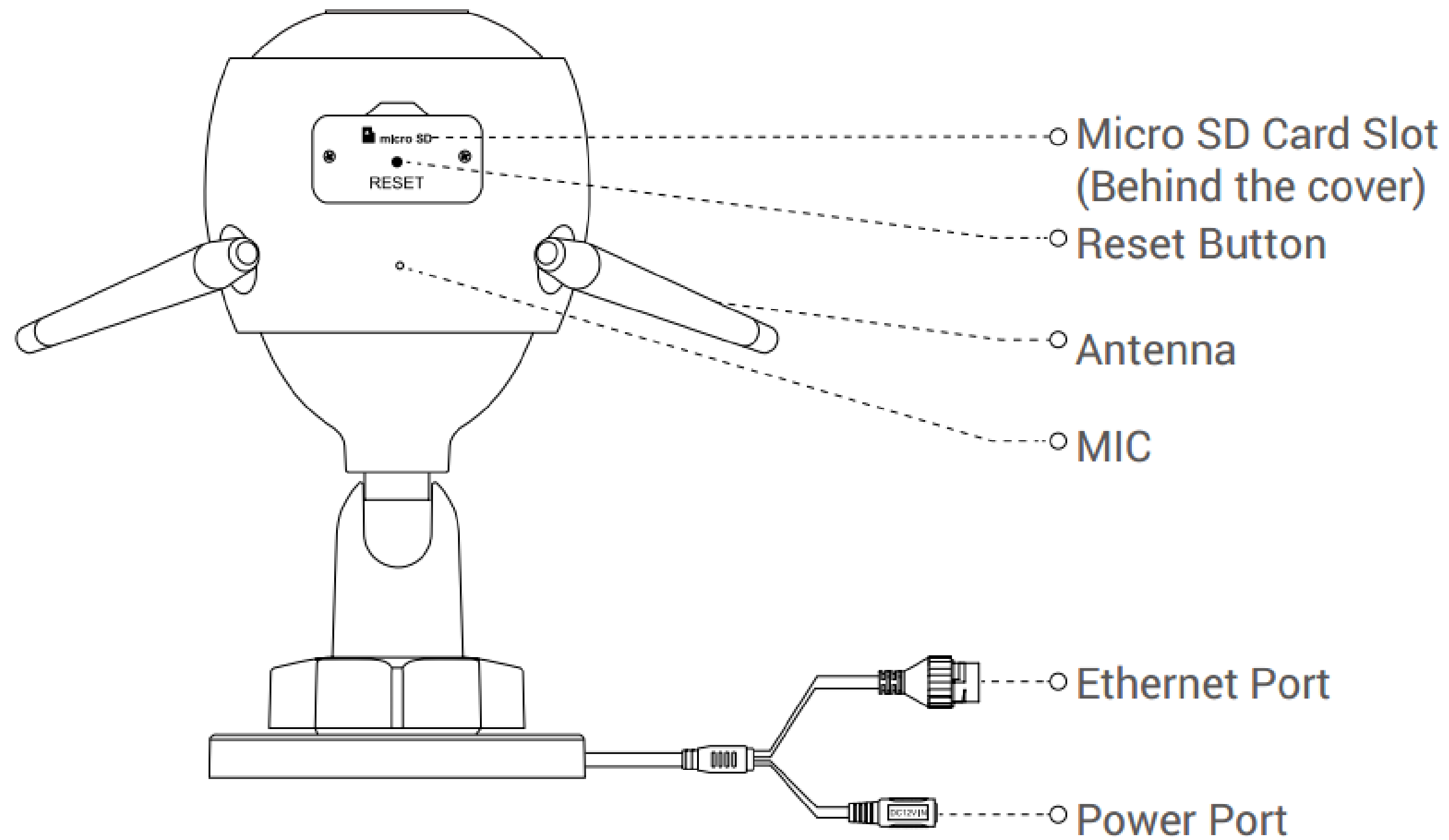

Micro SD Card Slot(Behind the cover):
Supports up to 256GB Micro SD Card

Reset Button: On the cover.

Mic: For audio pickup.

Ethernet Port: For network cable connection.

Power Port: For power adapter connection.

Spotlight: For color night view/Floodlight/Active light defense.

IR Light: For Black/White night view

LED Indicator

- Solid **Red**: Camera starting up.
- Slow-flashing **Red**: Wi-Fi connection failed.
- Fast-flashing **Red**: Camera exception (e.g. Micro SD card error).
- Solid **Blue**: Video being viewed in the EZVIZ app.
- Slow-flashing **Blue**: Camera running properly.
- Fast-flashing **Blue**: Camera ready for Wi-Fi connection.

02

—
Features





EZVIZ™

C3N

Outdoor Smart Wi-Fi Camera



AI Powered Human
Detection



Color Night Vision



Powerful Wi-Fi 2.4GHz with
Dual External Antennas



Weatherproof and
Dustproof, IP67

1080P

Full HD 1080P

H.265

H.265 Video Technology



MicroSD Slot for Local
Storage (Up to 256GB)



Secure Cloud Storage
(Optional)*

Color Night Vision

Equipped with two built-in spotlights, two IR lights and professional optical lenses, C3N can show vivid color night vision.



Color Night Vision



Black & White Night Vision

Three different Night Vision Modes adjustable

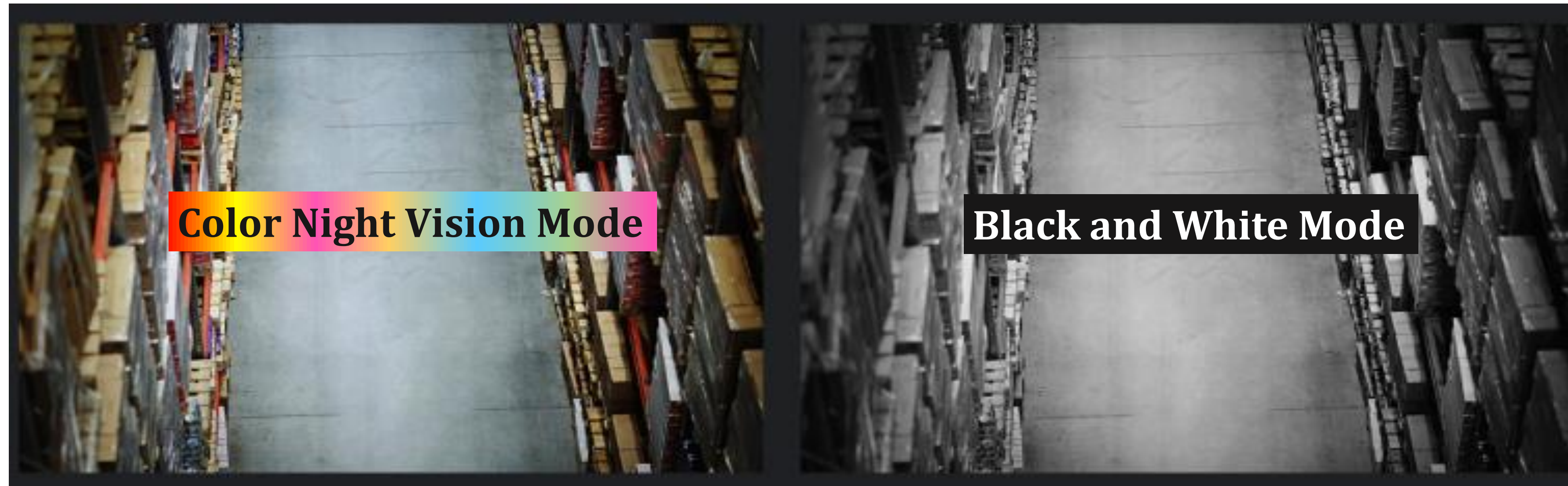

Smart Night Vision Mode

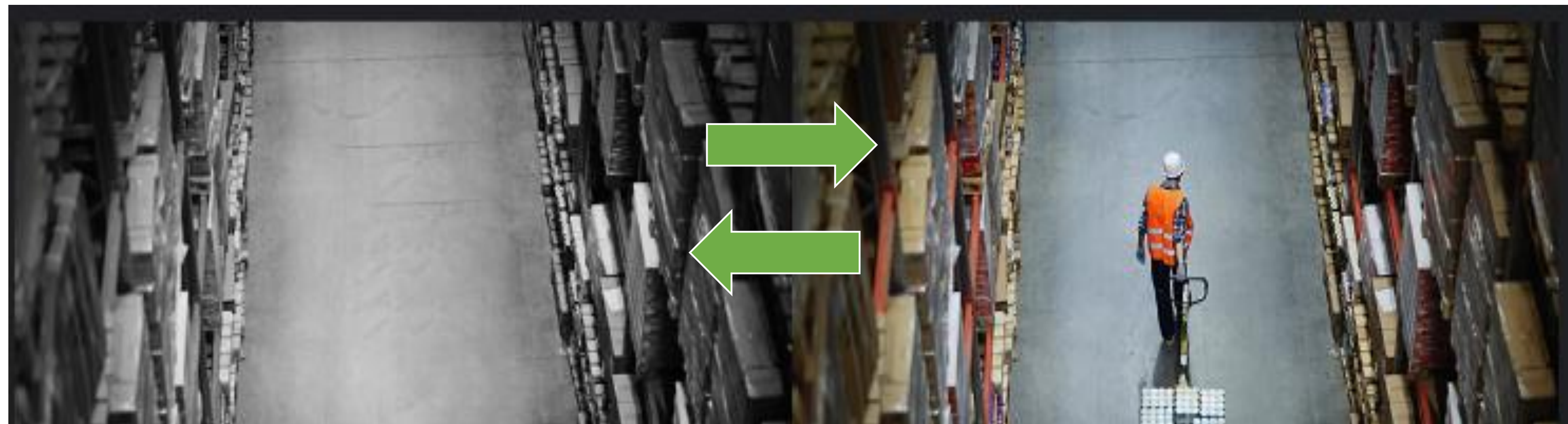

Three different Night Vision Modes adjustable

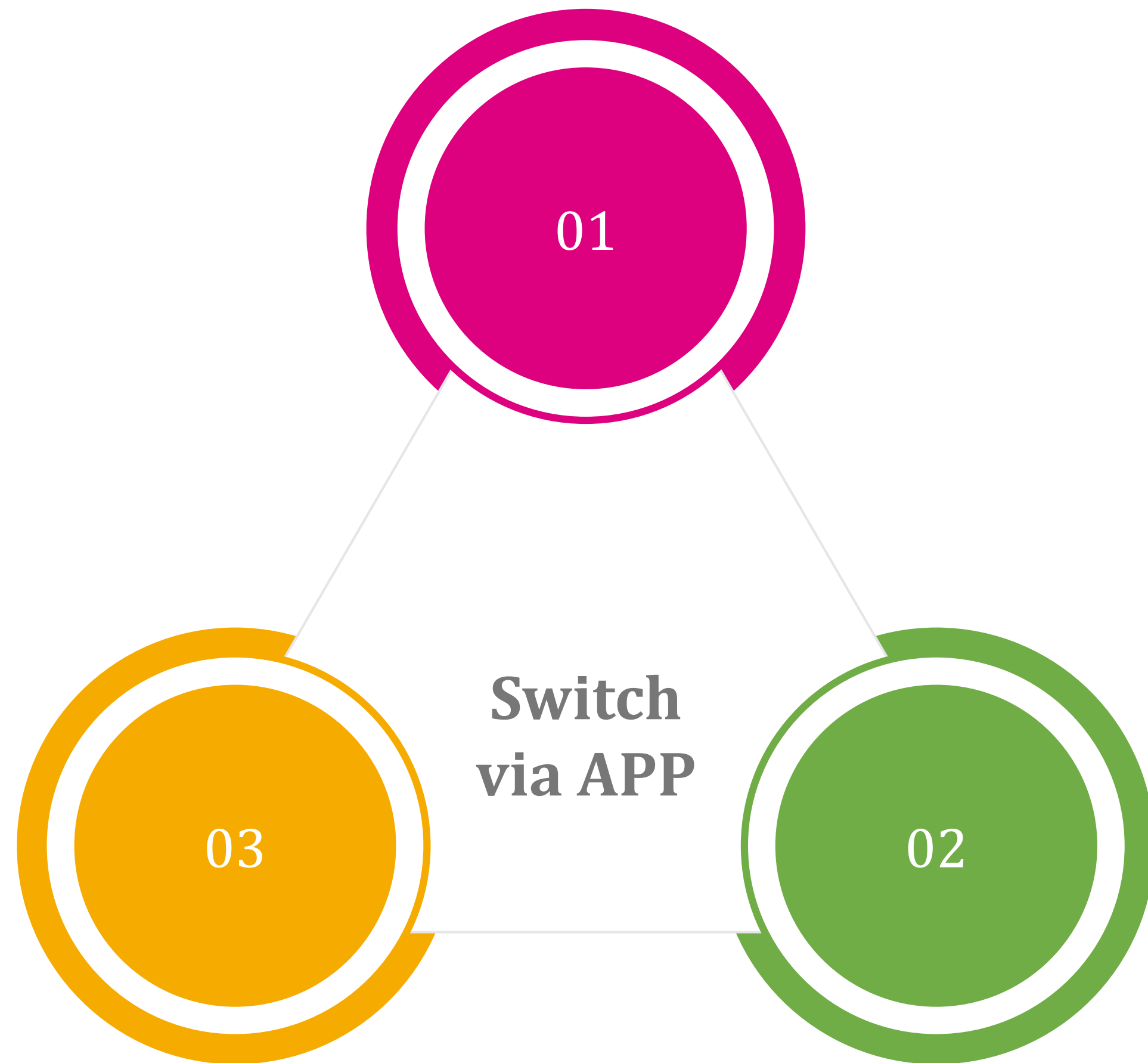

Color Night Vision Mode

Spotlights on, the night vision is colorful and also can be used as floodlights.



Black/ White Night Vision Mode

IR Lights on, of high invisibility and the image is black and white.



Smart Night Vision Mode

Black/White night vision by default. Switch to color night vision for **90s** when alarm is triggered.

AI Powered Human Detection



Equipped with AI algorithm in CPU chip , C3N supports human detection which means when it detects human in customized detection area, alarm notifications will be pushed to EZVIZ APP.

Based on the intelligent sensing of the actual environment, the intelligent PQ technology is used to adjust the screen brightness to avoid overexposure when people's approaching, while improving the picture quality of the humanoid area and keeping the humanoid area clearly visible.



C3N Night Vision



Normal IPC Night Vision

Active defense with strobe light



Upon detection of intruders, the camera will flash two spotlights to scare them off.

Audio Reception



With a built-in noise-canceling microphone, the C3N allows you to hear what's happening in high quality audio up to 5 meters. Use your smartphone to listen, wherever you might be.

Enhanced connection with dual external Wi-Fi antennas



Dual external Wi-Fi antennas equip C3N with better penetration and higher anti-interference performance.



H.265 Video Compression Technology

The camera features the advanced H.265 video compression technology, achieving better video quality with only half the bandwidth and half the storage space of the previous H.264 video compression standard.

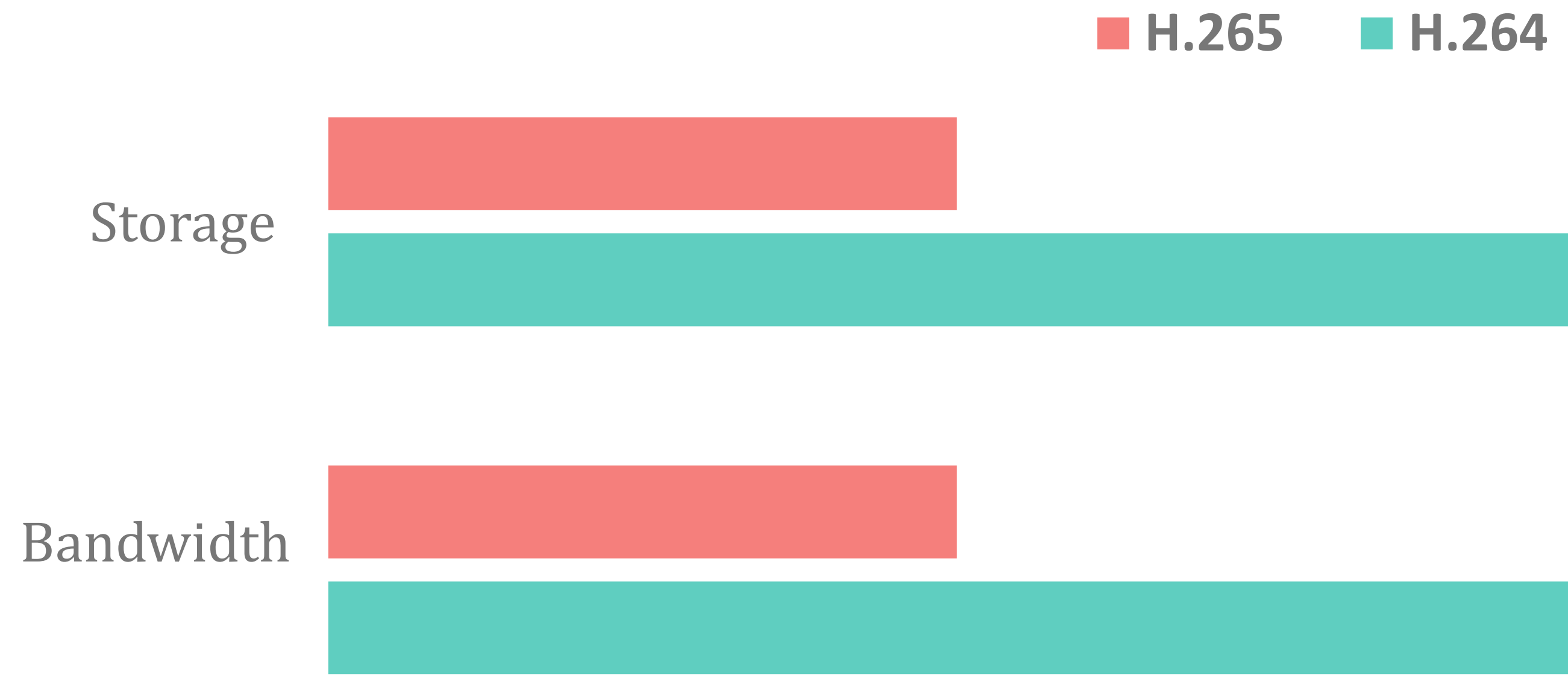

IP67 Water and Dust Proof

With a whole metallic enclosure and an IP67 rating, the camera can withstand rainy, sunny, stormy, and even snowy days, giving you year-round peace of mind.

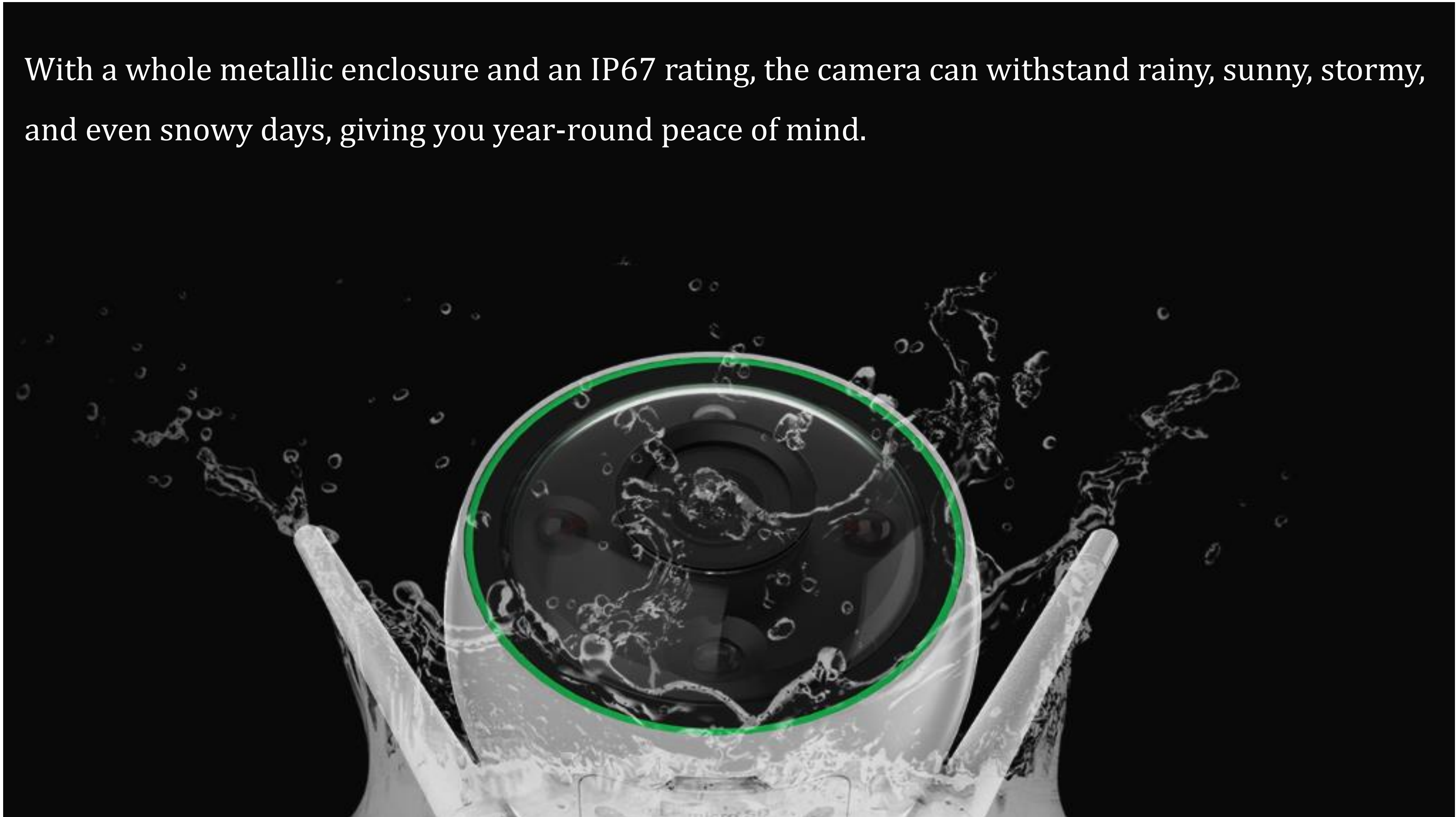

More reliable protection with Full Metal body

The aluminum alloy shell design provides better protection for C3N camera and easier heat dissipation, helping to extend the service life of the camera.



Simple installation

The C3N camera features a 360° swivel and base so that you can install it on your ceiling or wall securely. In just a few minutes, you have a sophisticated security system.



Multiple storage options

With multiple storage options, you can choose where to save your recordings. The C3N camera can even save to all three locations at the same time for added backup in case the camera is damaged, or your network crashes.



Supports MicroSD Card



Encrypted Cloud Storage*







EZVIZ NVR

*Cloud storage service is only available in certain markets. Please verify the availability before making any purchase.

Bullet Camera

Please make sure the product is under the latest version.



	C3W (ezGuard)	C3W (Color night vision)	C3WN	C3X	C3N
Appearance					
	Red Ring around without Spot lights	Red Ring around with Spot lights	Green Ring around without Spot lights	Silver Ring around with dual lens	Green Ring in front with Spot lights
Resolution	HD, Full HD	Full HD	Full HD	Full HD	Full HD
Video coding standard	H.264	H.264, H.265	H.264	H.264, H.265	H.264, H.265
User defined alarm tones	Not support	Supports	Not support	Supports	Not support
Active Light and Sound alarm	Supports	Supports	Not support	Supports	Not support (Only with strobe light)
IP Grade	IP 66	IP 67	IP 66	IP 67	IP 67
Color night image	Not support	Supports	Not support	Supports	Supports
Two-Way talk	Supports	Supports	Not support	Supports	Not support
Max. SD card	256G	256G	256G	256G	256G
Human/Car Shape Detection	Not support	Not support	Not Support	Supports	Human Detection
AI Technology	Not equipped	Not equipped	Not equipped	Equipped	Equipped

03

Operation



First use---Set Up

1. Get the EZVIZ App

1. Connect your mobile phone to Wi-Fi using your 2.4GHz network.
2. Search for “EZVIZ” in App Store or Google Play.
3. Download and install the EZVIZ app.
4. Launch the app, and register an EZVIZ user account.

2. Setup

1. Power on your camera.
2. Log in to your EZVIZ app user account.
3. Connect your camera to the Internet.
4. Add your camera to your EZVIZ account.

2.1 Power-on

Steps:

1. Connect the power adapter cable to the camera's power port.
2. Plug the power adapter into an electrical outlet.

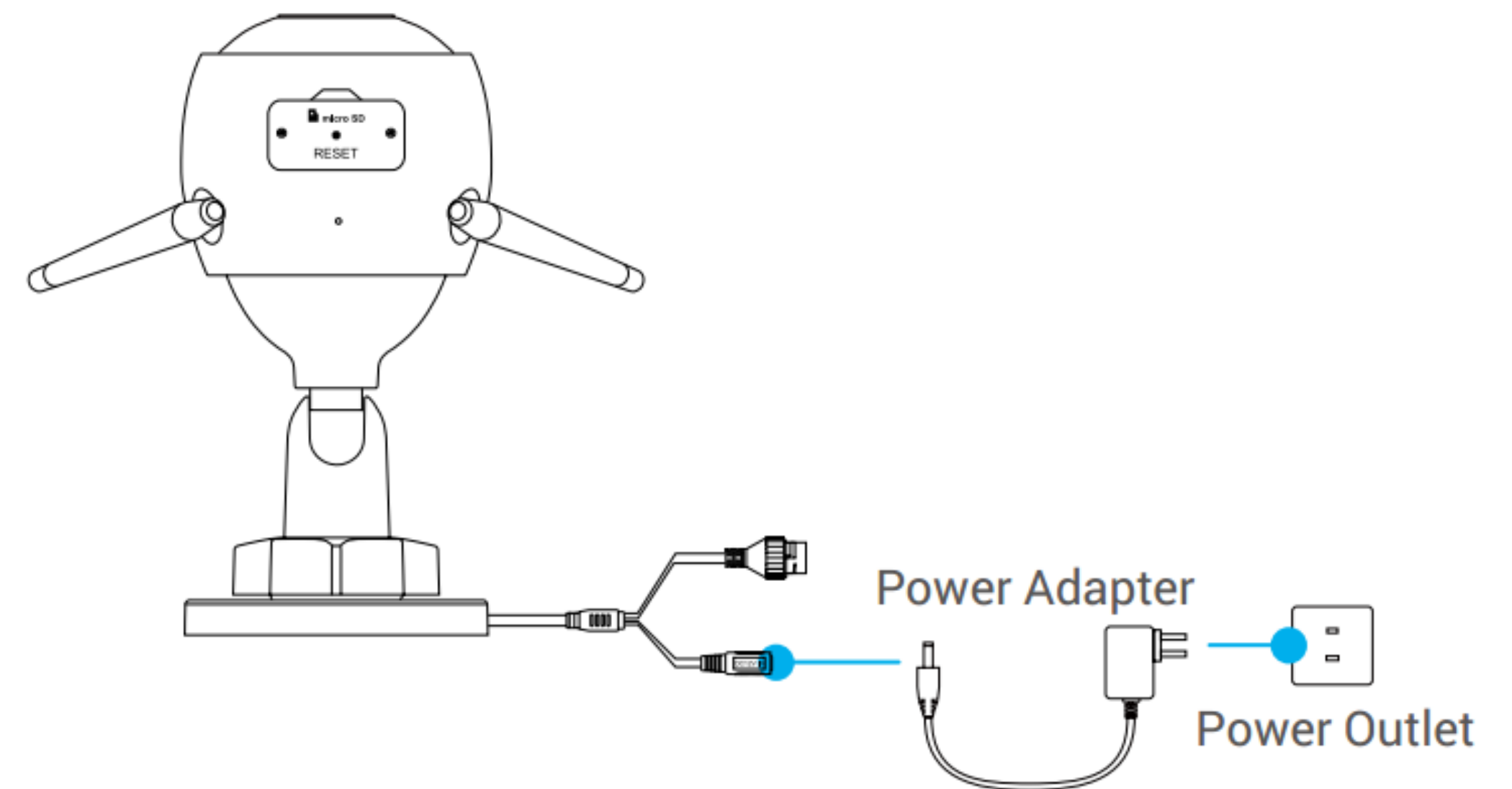

- The LED turning **fast-flashing blue** indicates that the camera is powered on and ready for network configuration.

First use---Set Up

2.2 Connect to the Internet

Option 1: Use the EZVIZ app to configure Wi-Fi.

1. Log in to your account using the EZVIZ app.
 2. On the Home screen, tap “+” on the upper-right corner to go to the Scan QR Code interface.
 3. Scan the QR code on the Quick Start Guide cover or on the body of the camera.
 4. Follow the EZVIZ app wizard to finish Wi-Fi configuration.
- Please choose to connect your camera to the Wi-Fi to which your mobile phone has connected.
 - Hold the reset button for 5s to restart and set all parameters to default under the following cases:
 - The camera fails to connect to your Wi-Fi network.
 - You want to change to another Wi-Fi network.

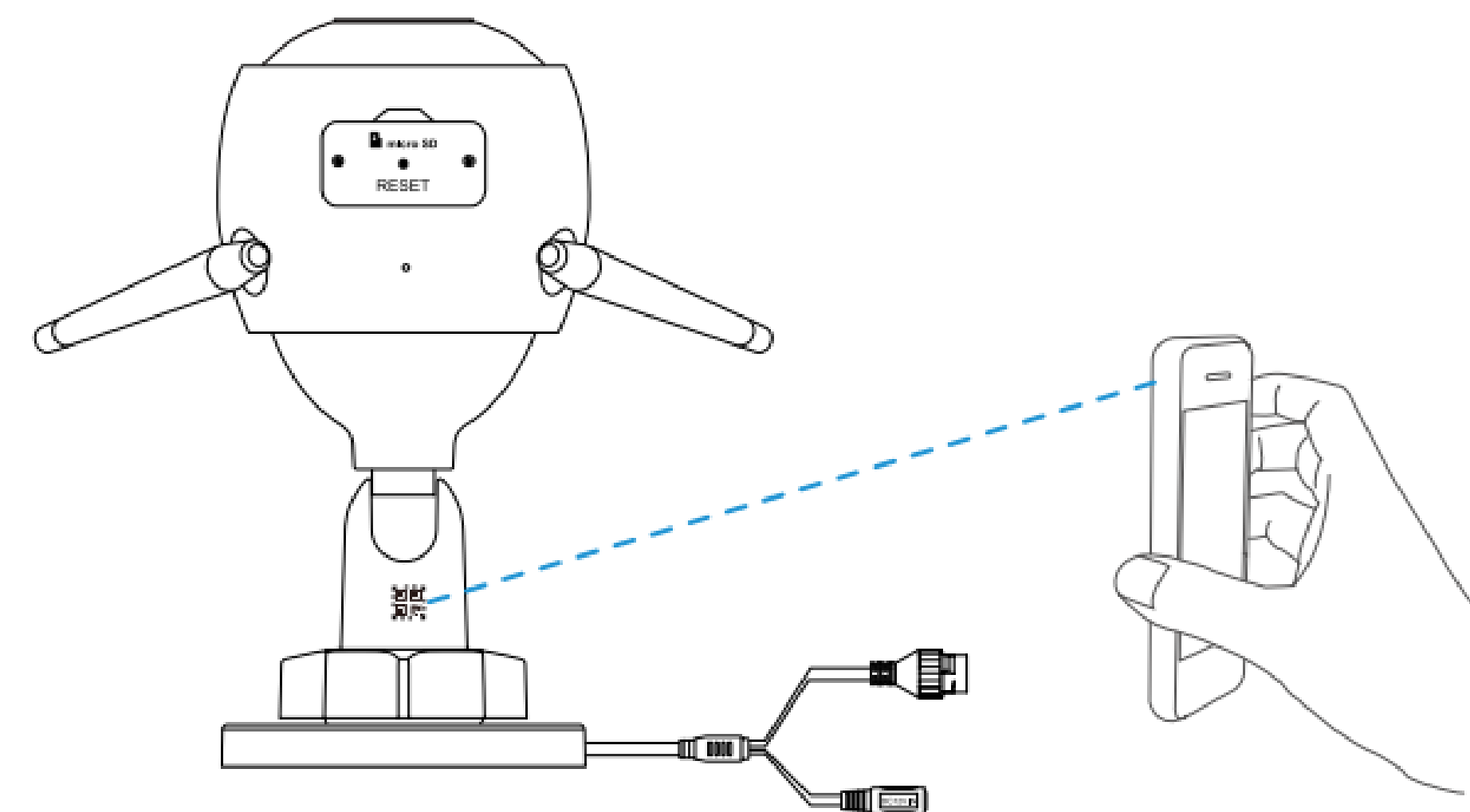
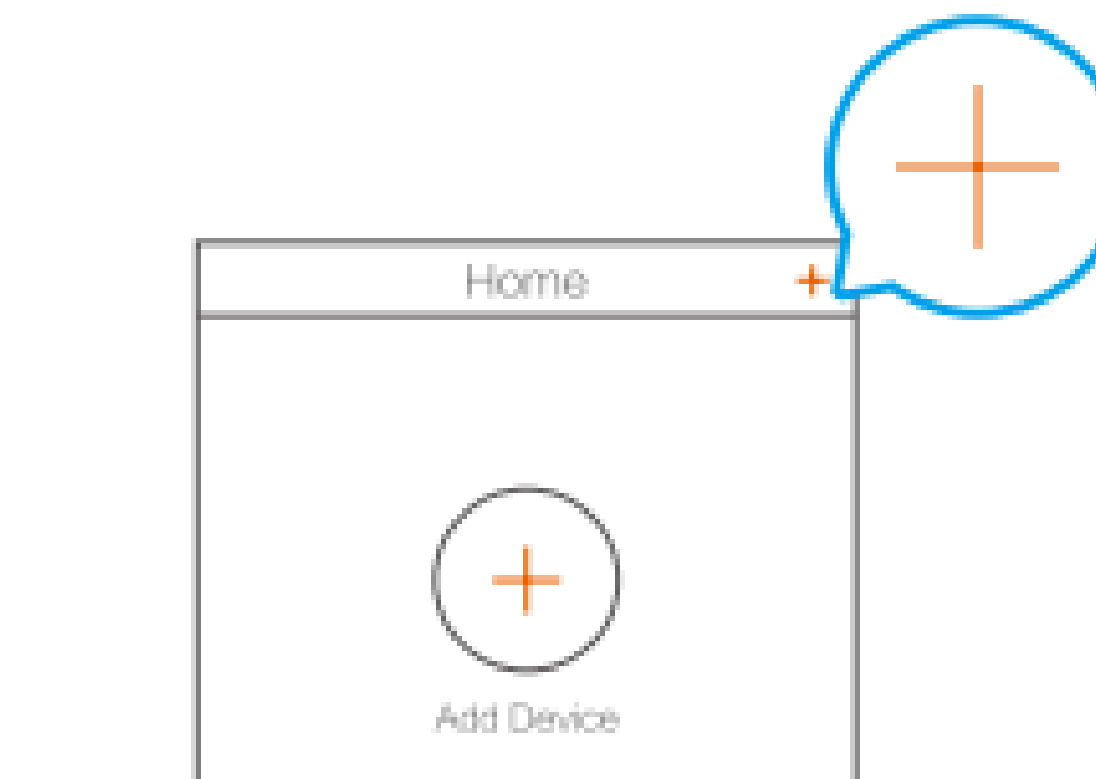

First use---Set Up

2.2 Connect to the Internet

Option 2: Connect your Wi-Fi camera to a router.

1. Connect the camera to the LAN port of your router with the Ethernet cable.
2. Log in to your account using the EZVIZ app.
3. On the Home screen, tap “+” on the upper-right corner to go to the Scan QR Code interface.
4. Scan the QR code on the Quick Start Guide cover or on the body of the camera.
5. Follow the wizard to add the camera to the EZVIZ app

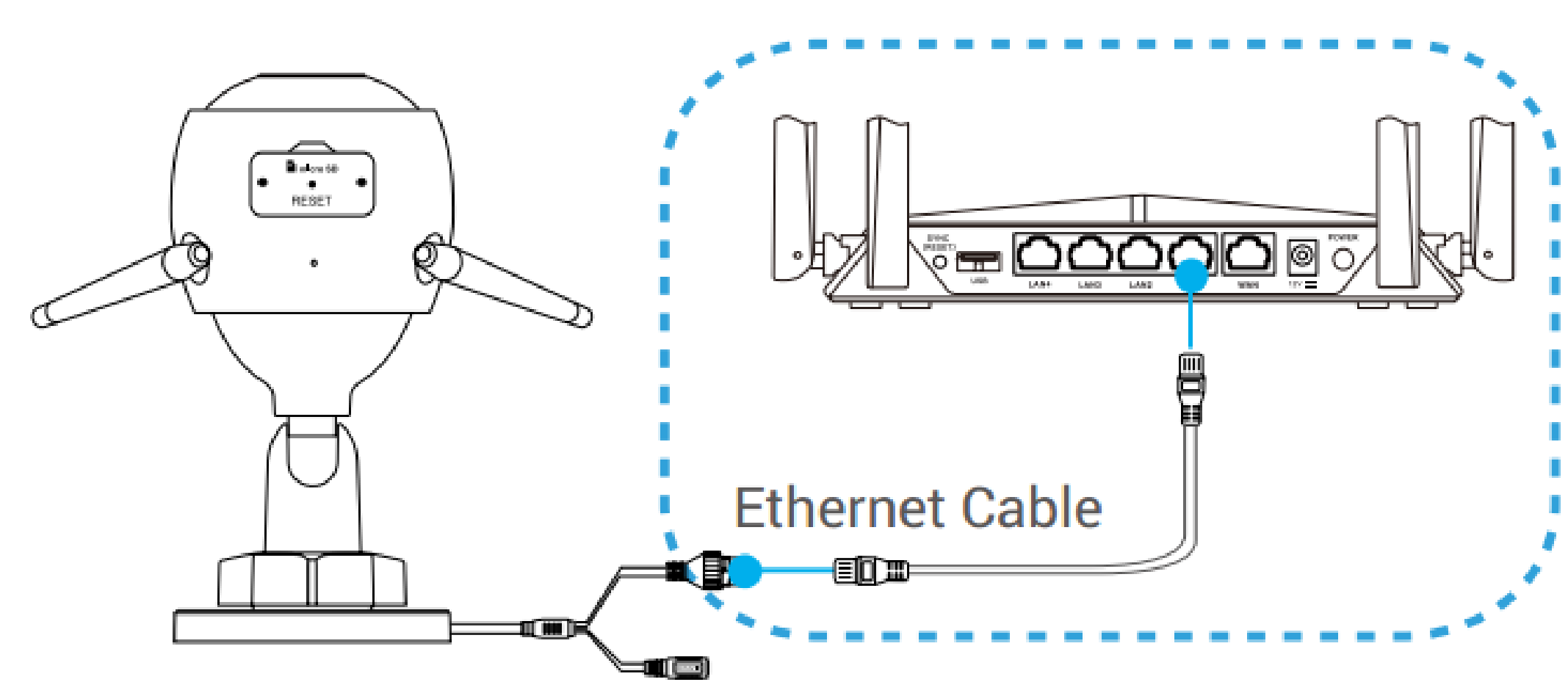

Ethernet Cable

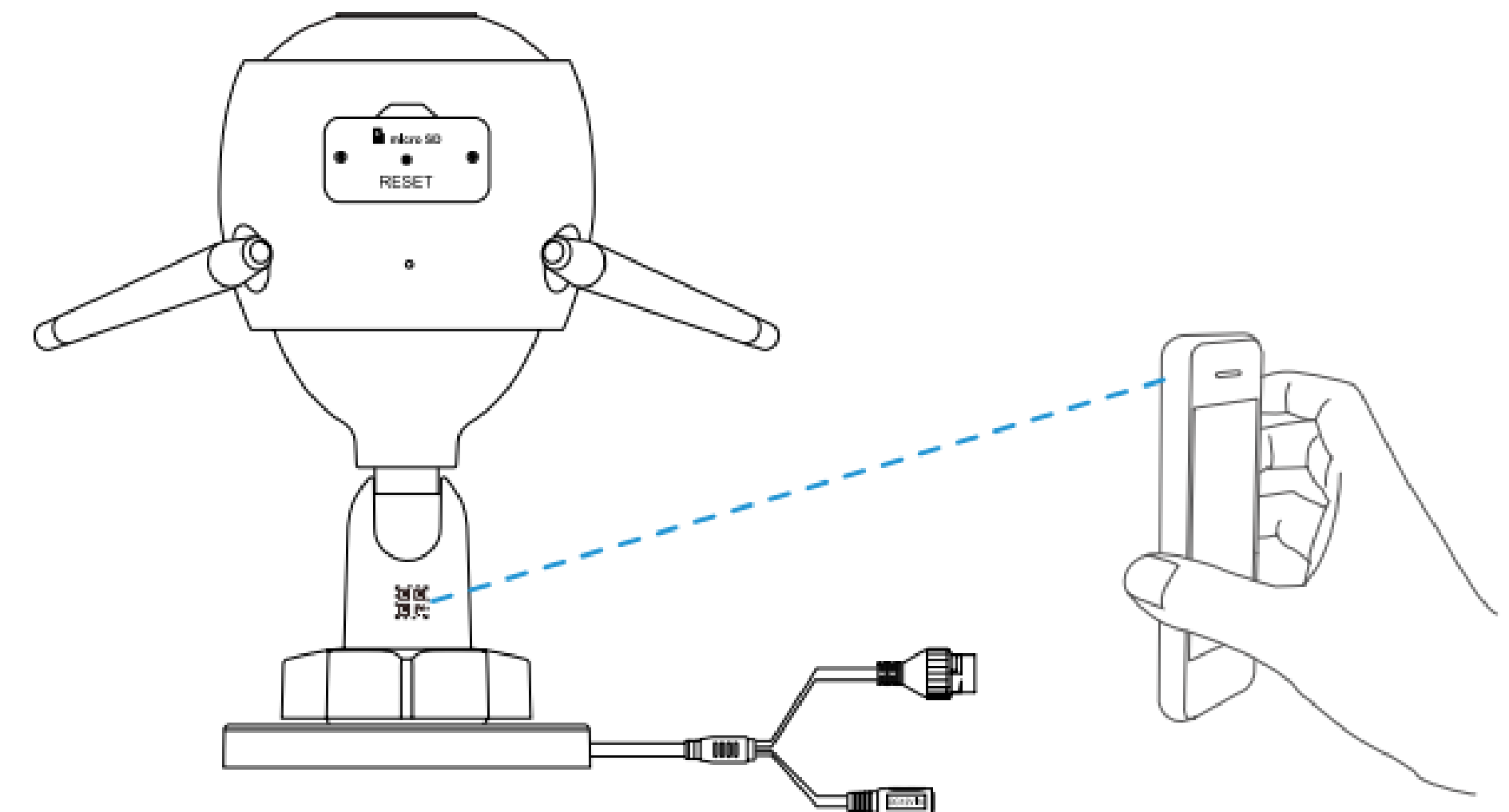
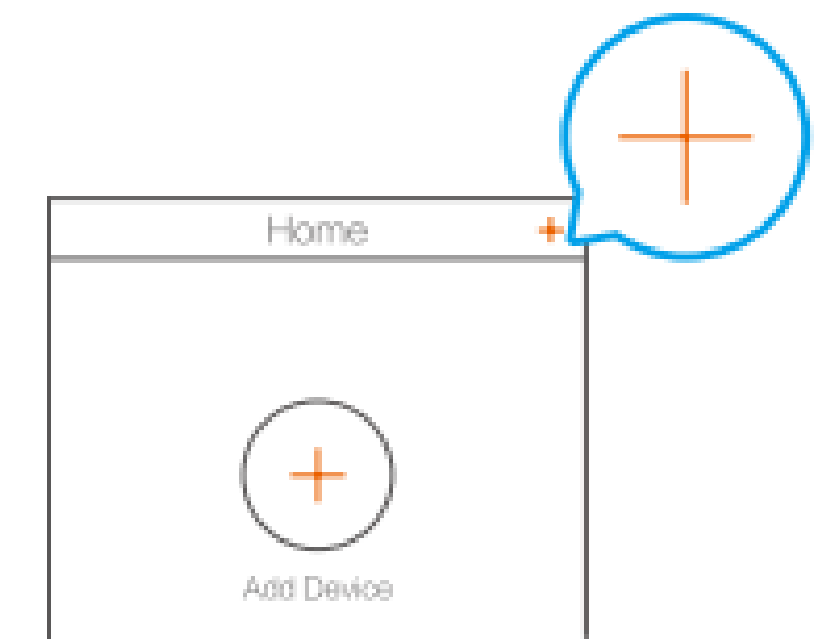

First use---Installation

You can install the camera on the wall or ceiling.

- Make sure the wall is strong enough to withstand three times the weight of the camera.
- Recommended installation height: 3m (10 inch).
- Avoid positioning the camera in an area that gets a lot of light shining directly into the camera lens.

Install the Camera

- Place drill template onto the surface you have chosen to mount the camera.
- (For the cement wall/ceiling only) Drill screw holes according to the template, and insert three anchors.
- Use three metal screws to fix the camera base according to the template.

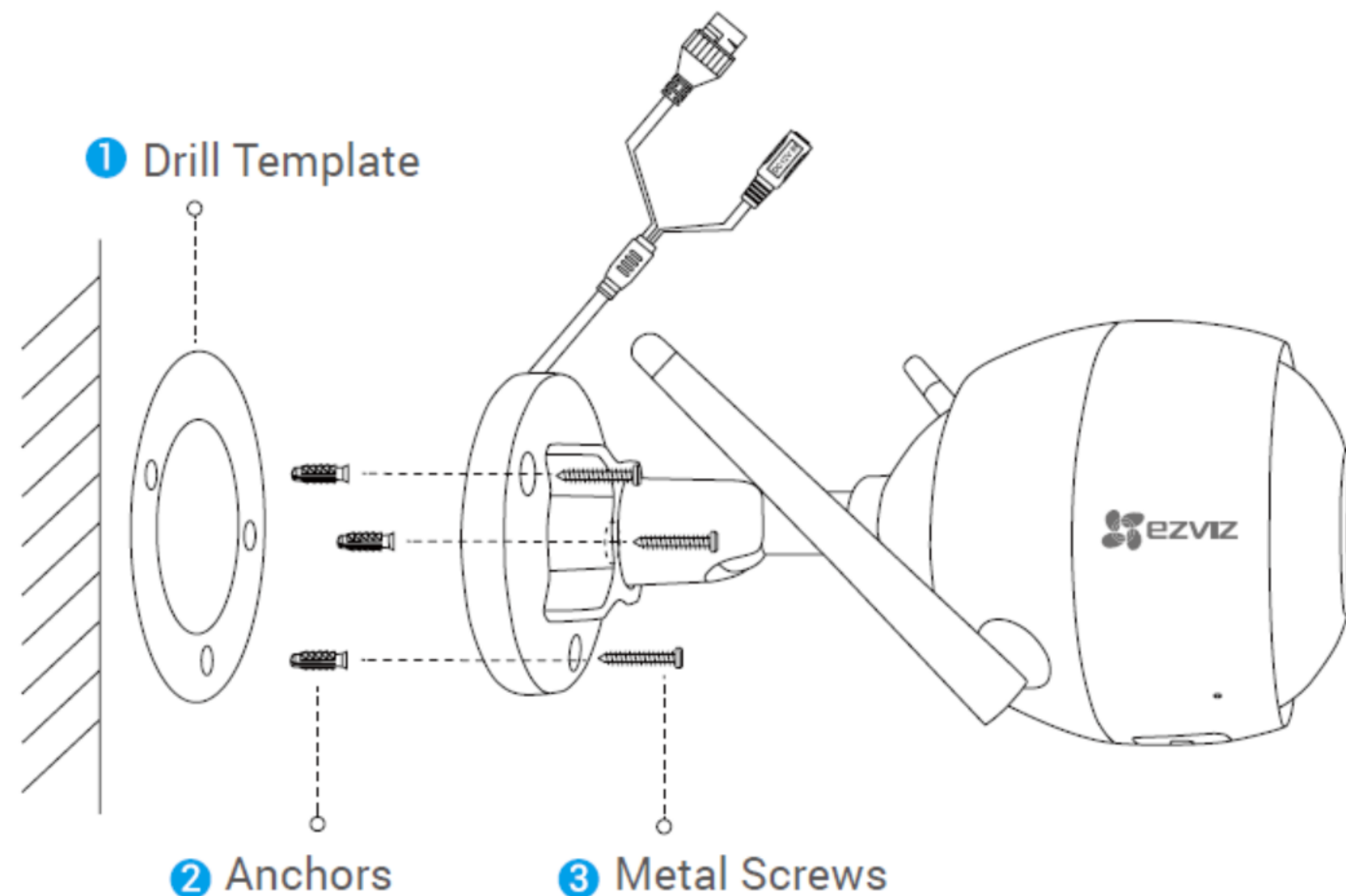

Adjust the Surveillance Angle

- Loosen the adjusting screw.
- Adjust the surveillance angle as your desired place.
- Tighten the adjusting screw when you have your camera in the position you want.

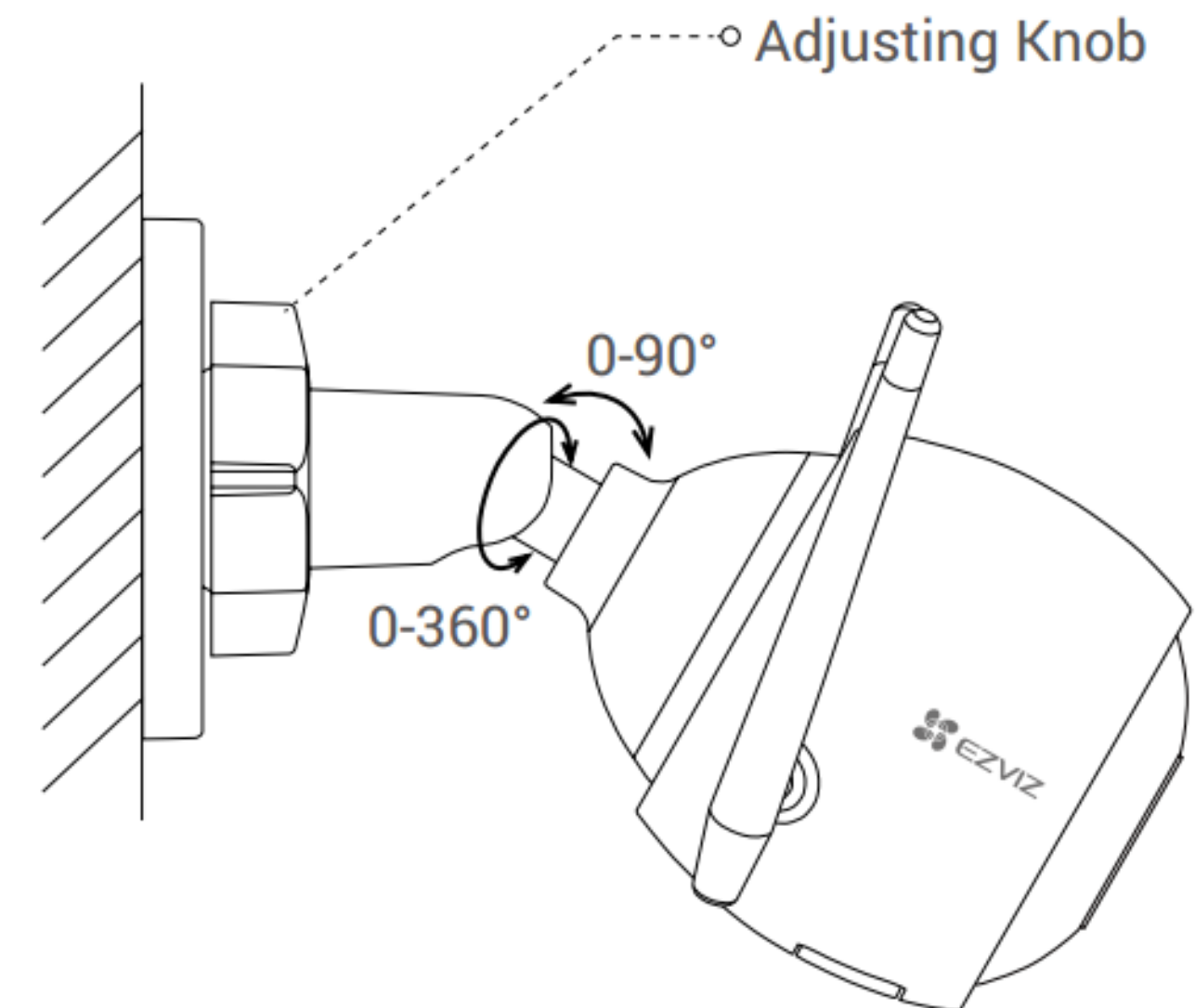

First use---Install the SD Card(Optional)

1. Remove the cover on the camera.
2. Insert the Micro SD card (sold separately) into the card slot as shown in the figure below.
3. Place the cover back on.
5. In the EZVIZ app, tap the Storage Status in the Device Settings interface to check the SD card status.
6. If the memory card status displays as Uninitialized, tap to initialize it.

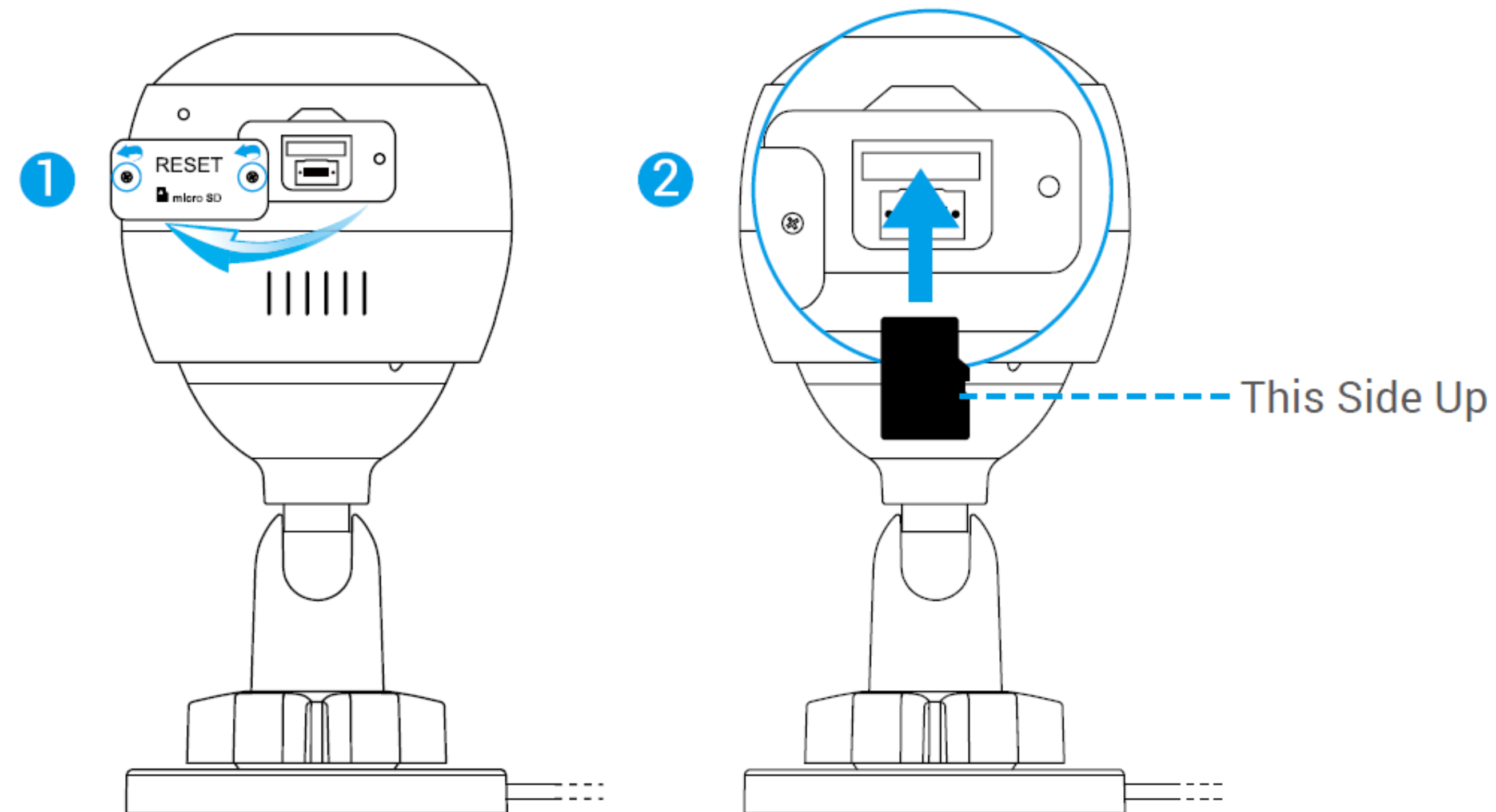

APP---Night Vision Mode

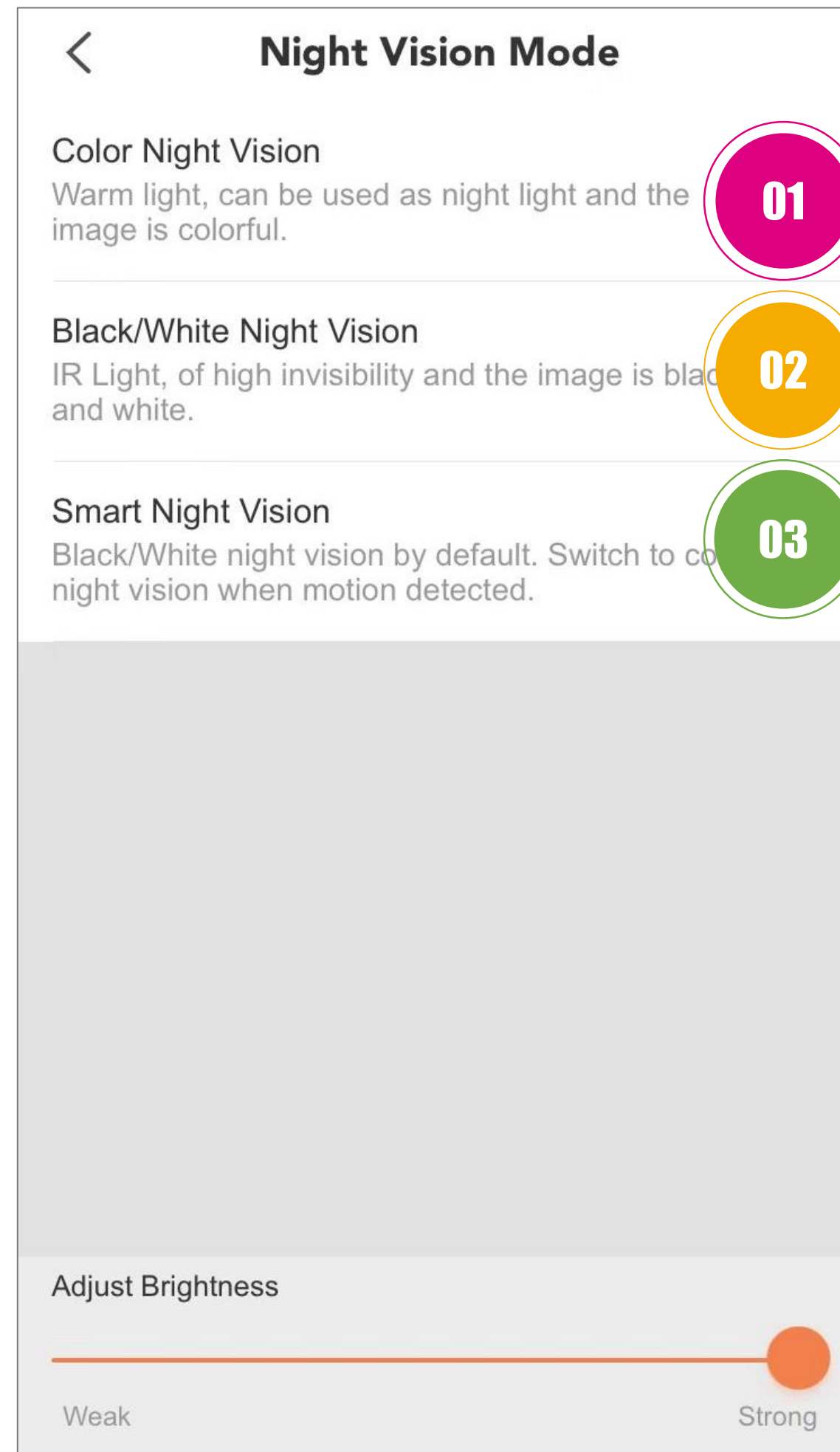
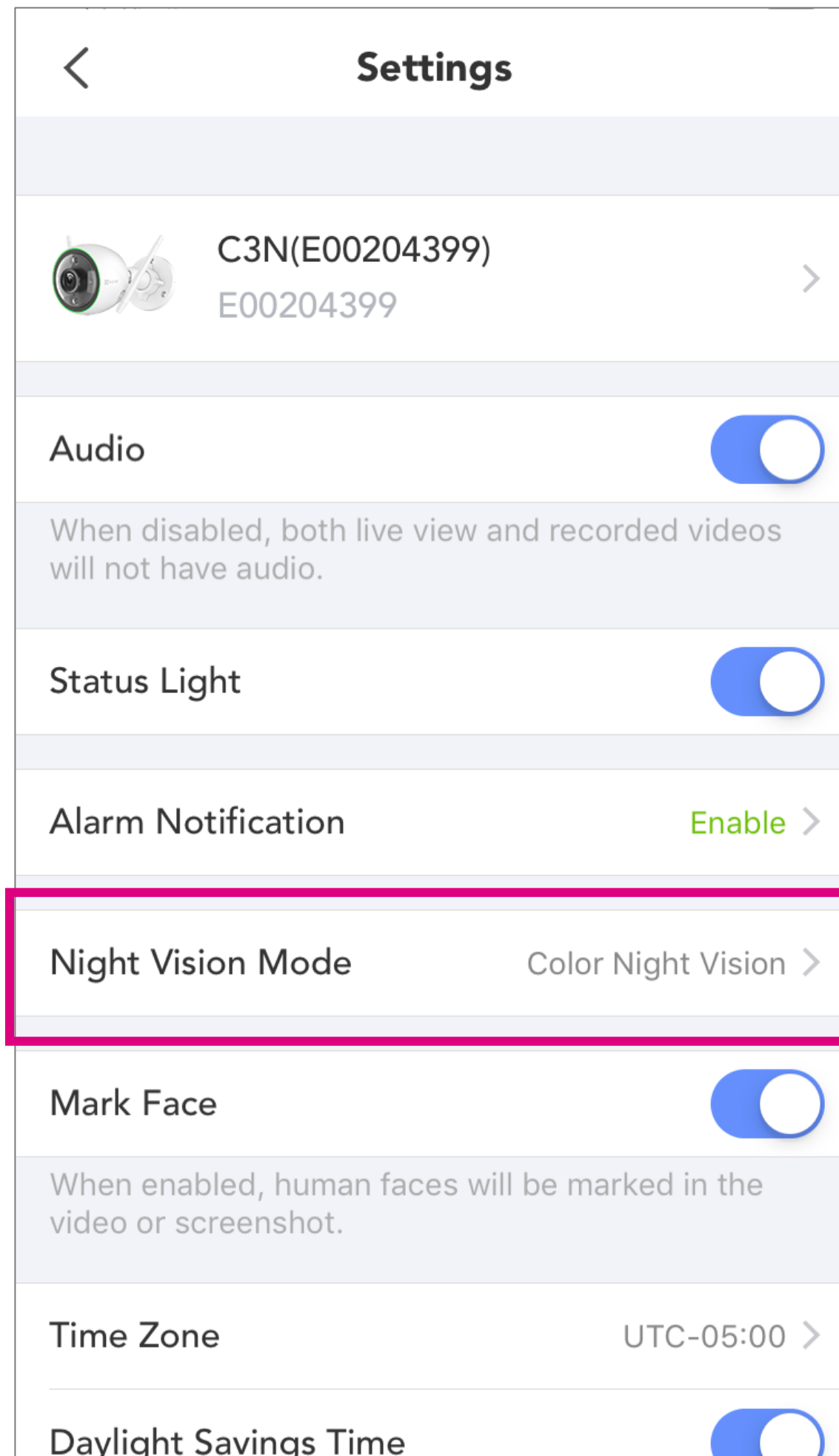

Color Night Vision Mode

Spotlights on, the night vision is colorful and also can be used as floodlights.



Black/ White Night Vision Mode

IR Lights on, of high invisibility and the image is black and white.



Smart Night Vision Mode

Black/White night vision by default. Switch to color night vision for **90s** when alarm is triggered.

APP---AI Human-Shape/Image Change Detection

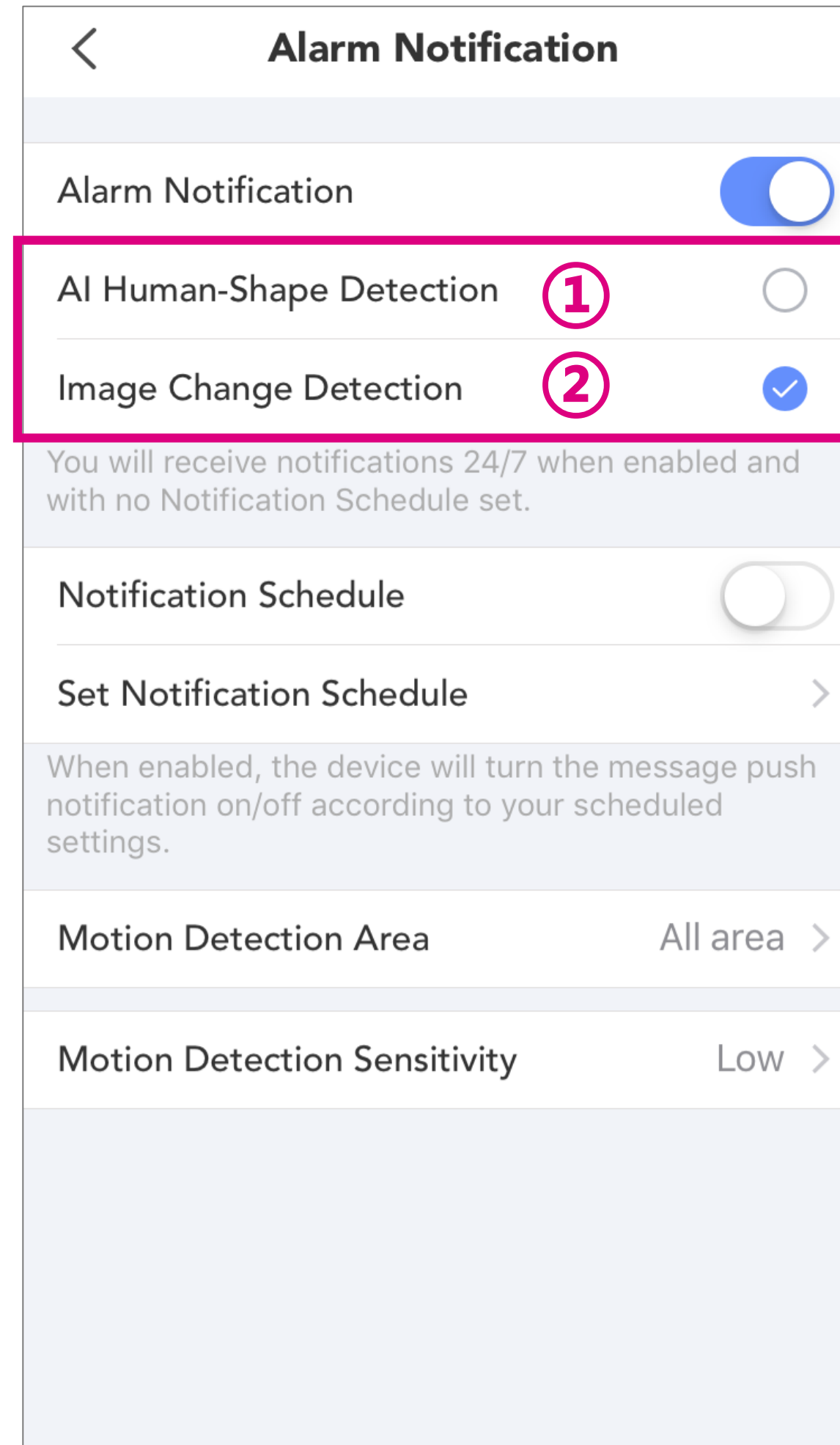
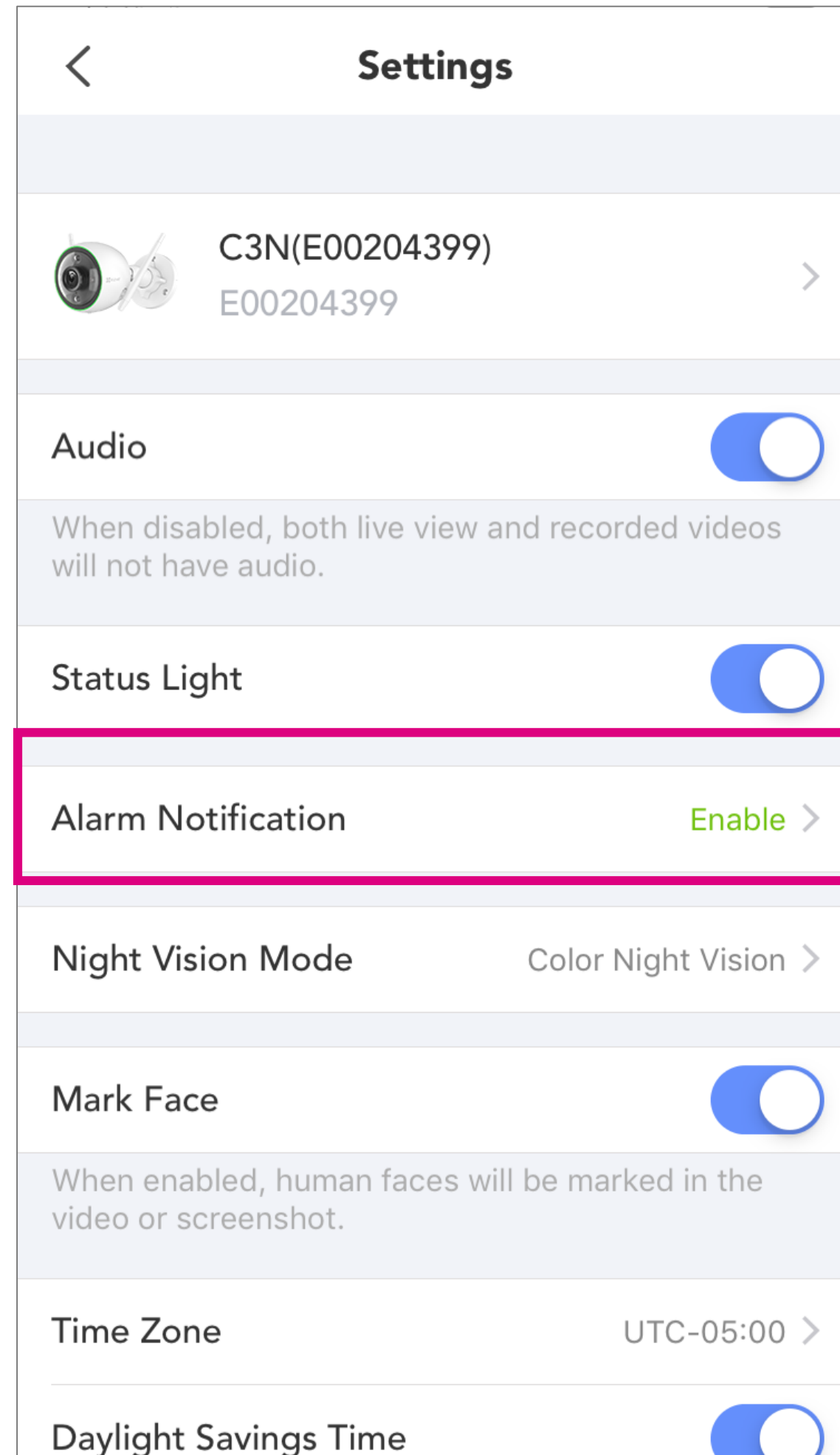

① AI Human-Shape Detection: Receive notification when detecting human-shape

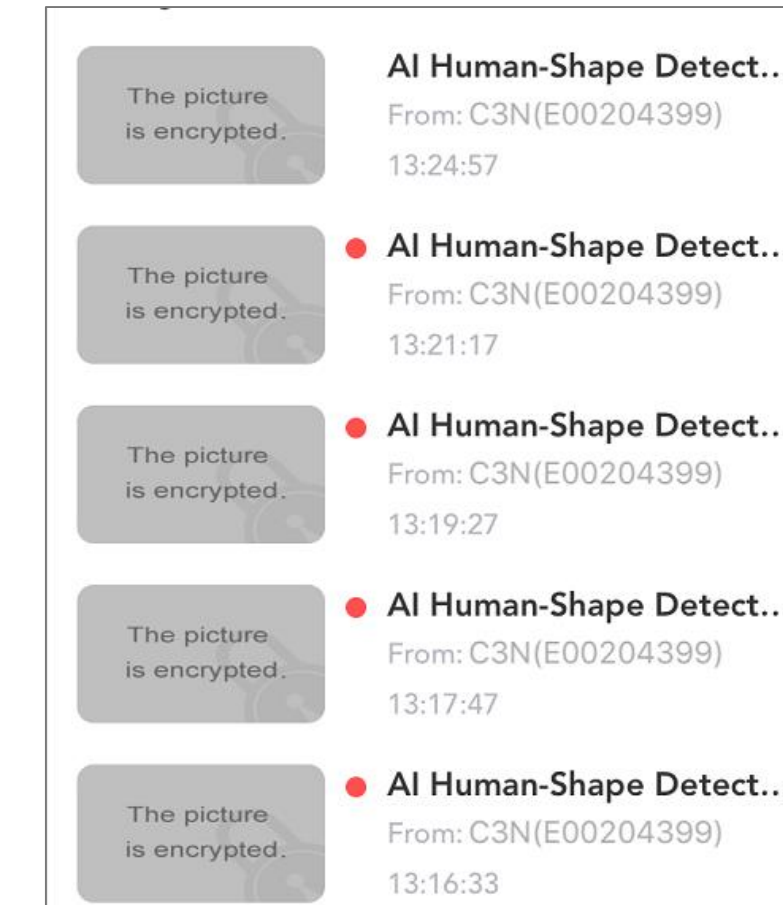

② Image Change Detection: Receive notification when detecting image changes

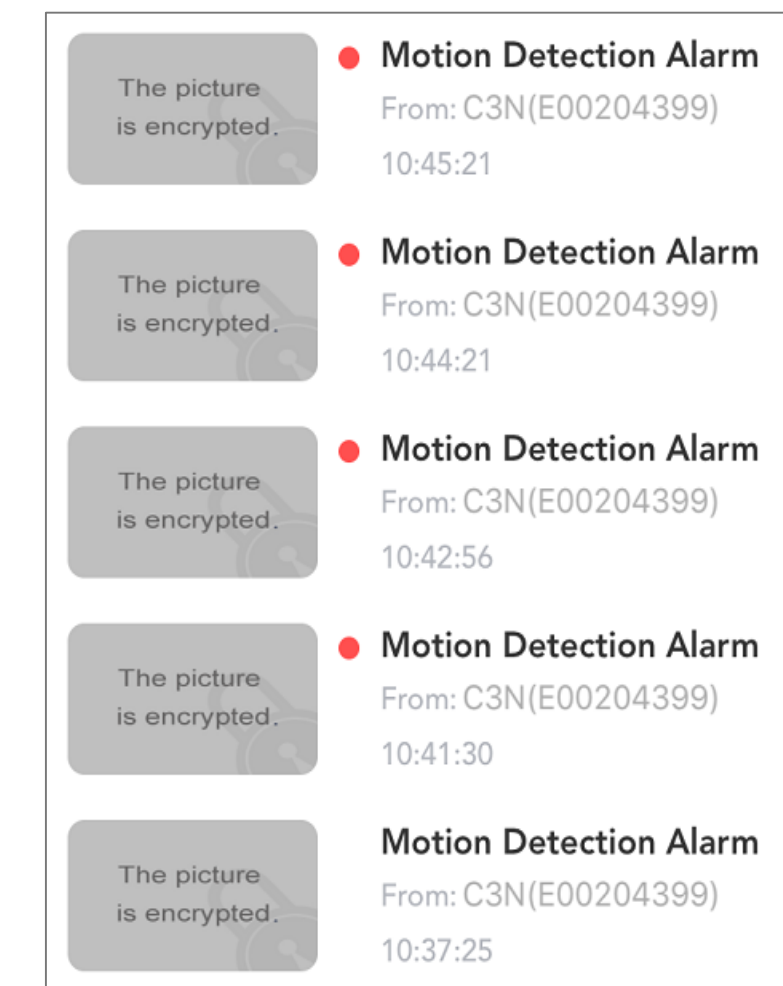

APP---Customized Motion Detection Area

 Only for Motion Detection

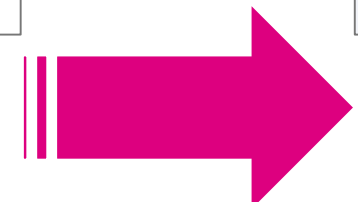
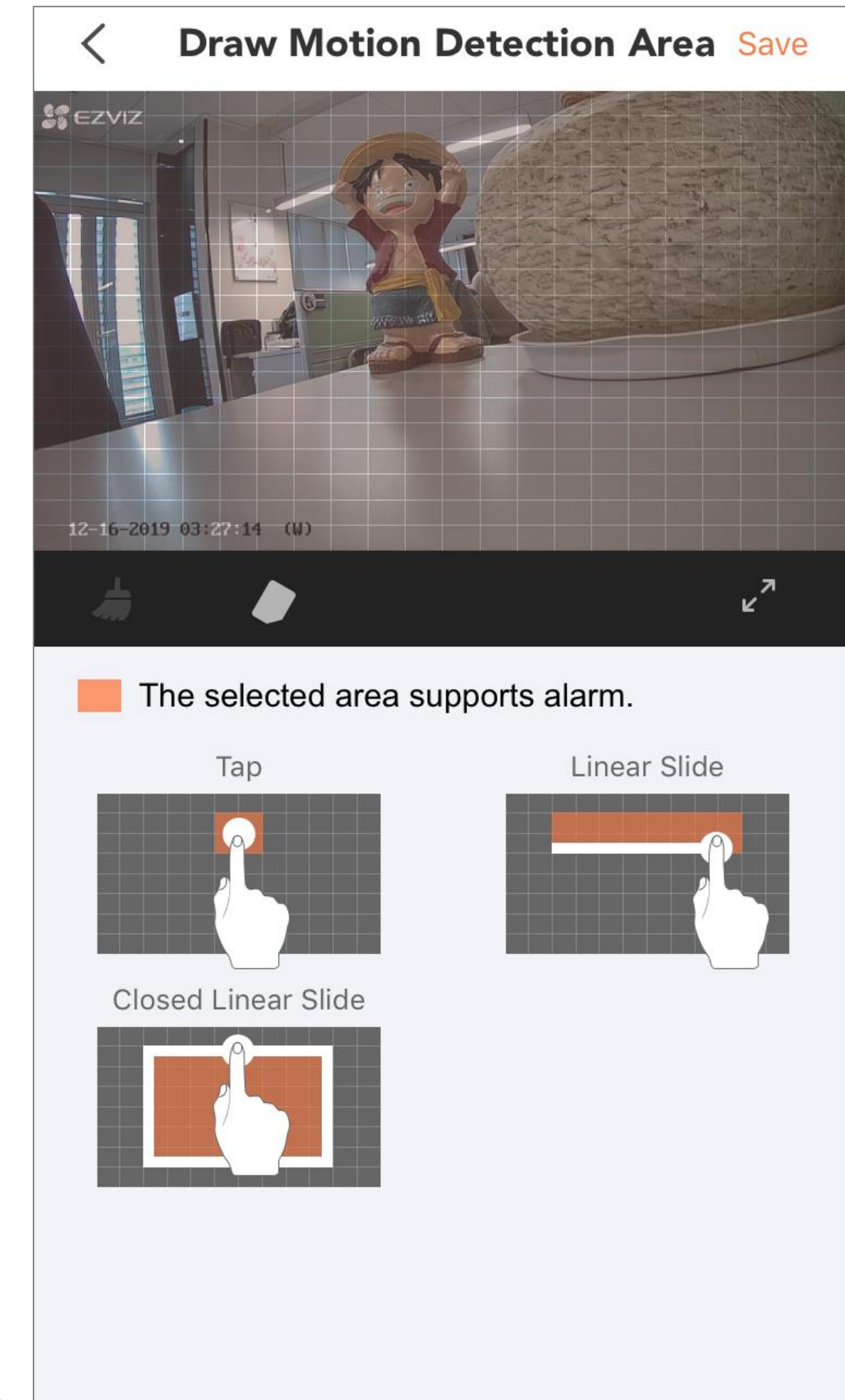
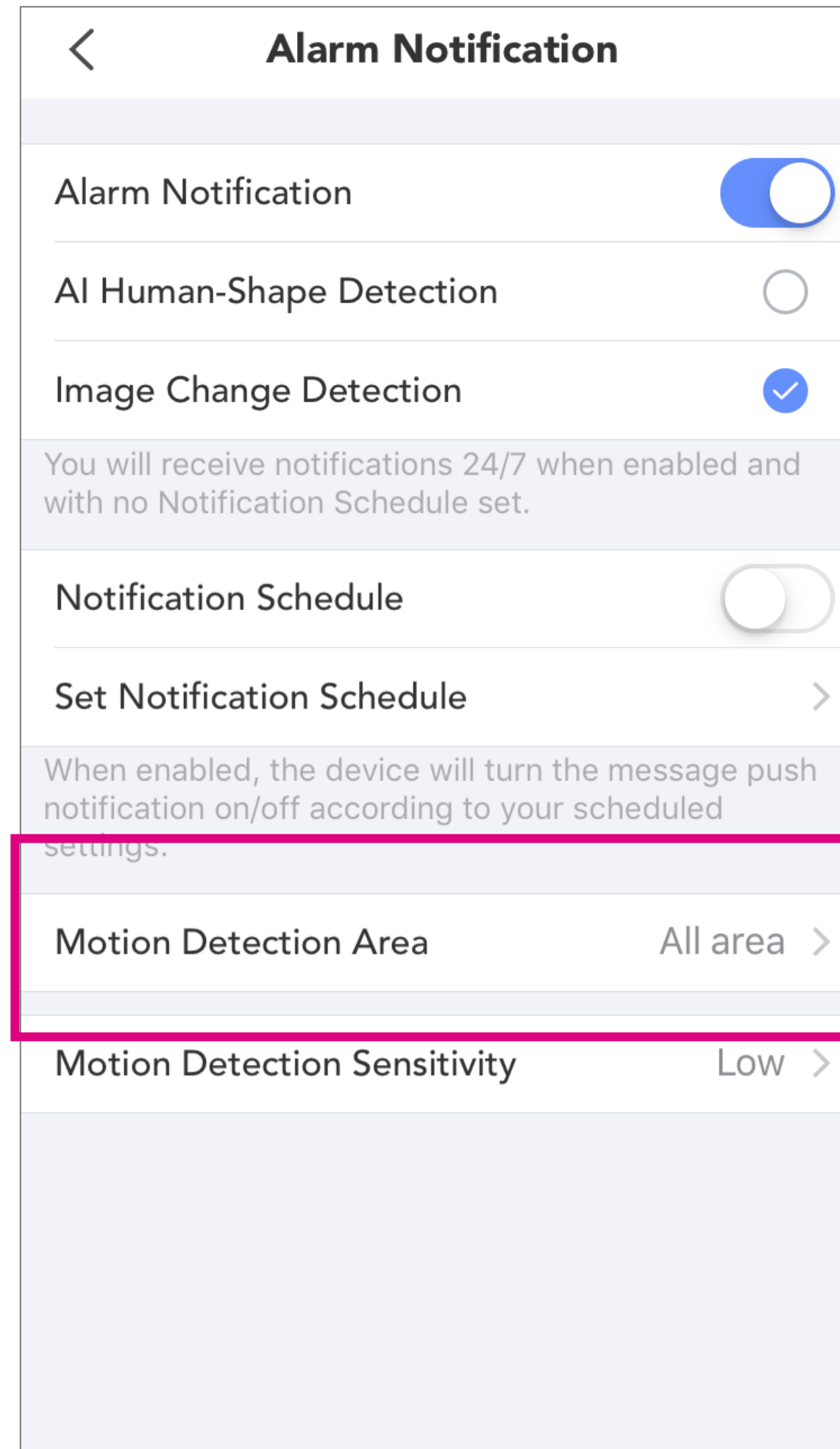
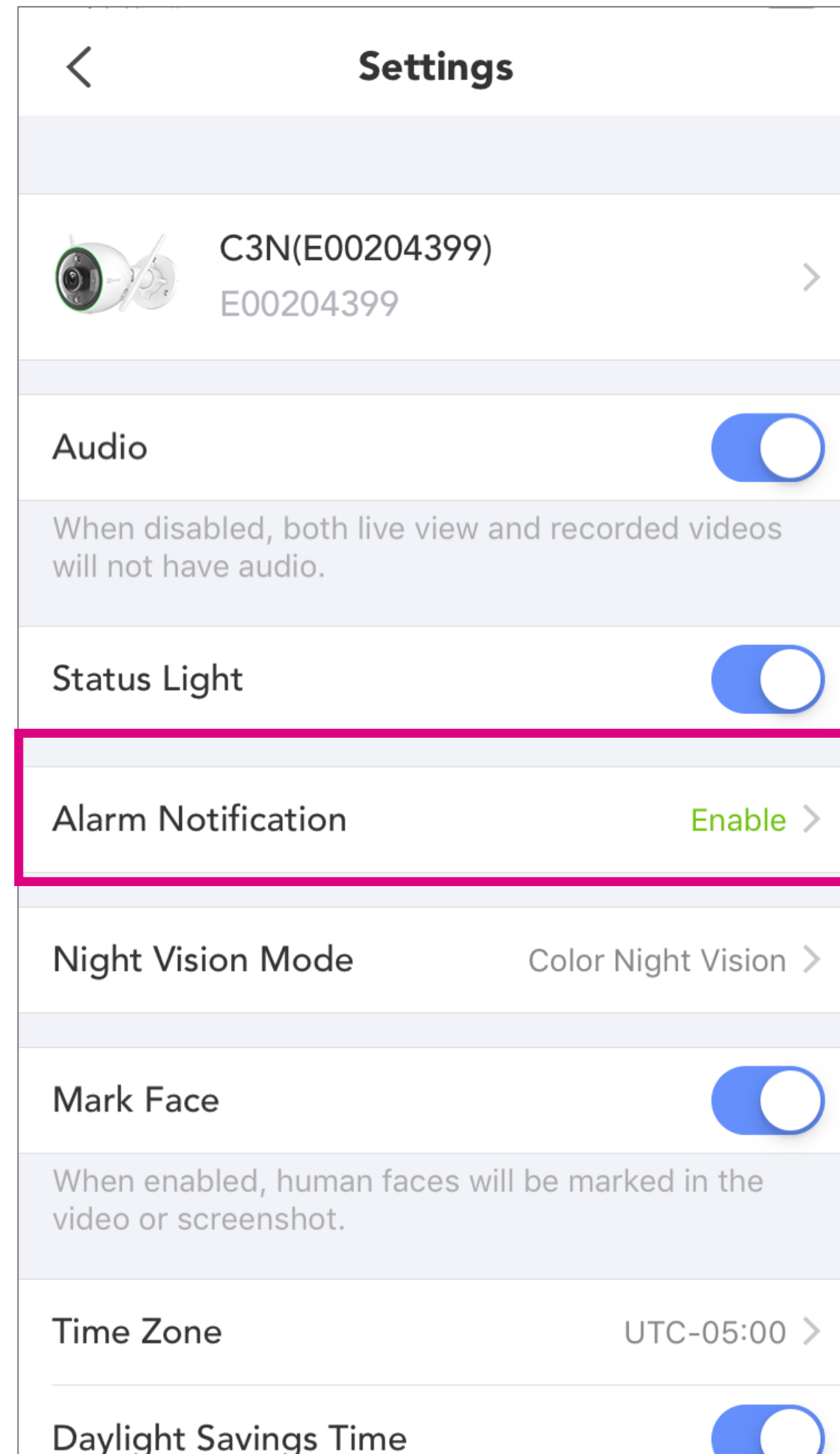

APP---Cloud Storage

 Cloud storage service is only available in certain markets. Please verify the availability before making any purchase.

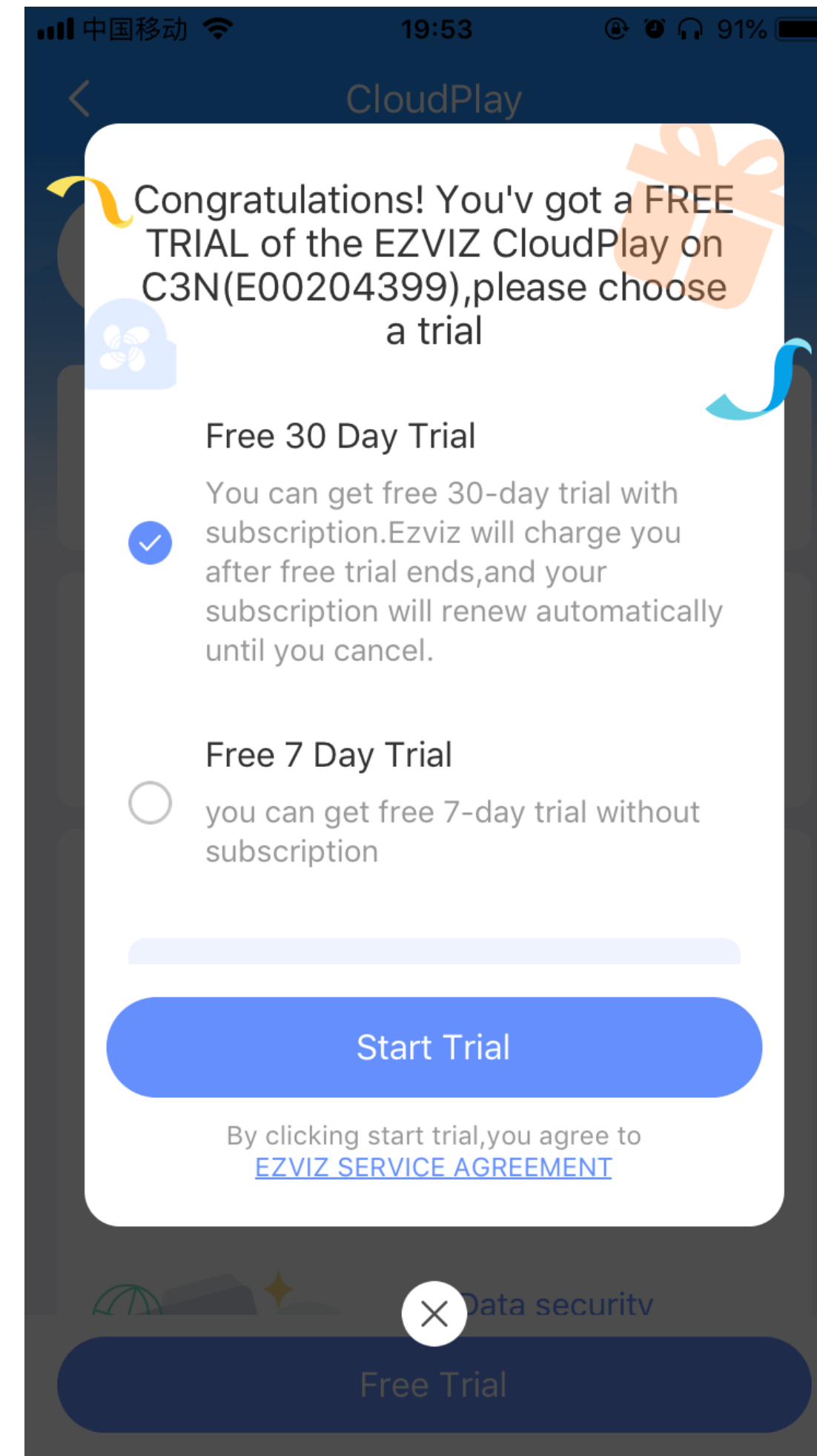
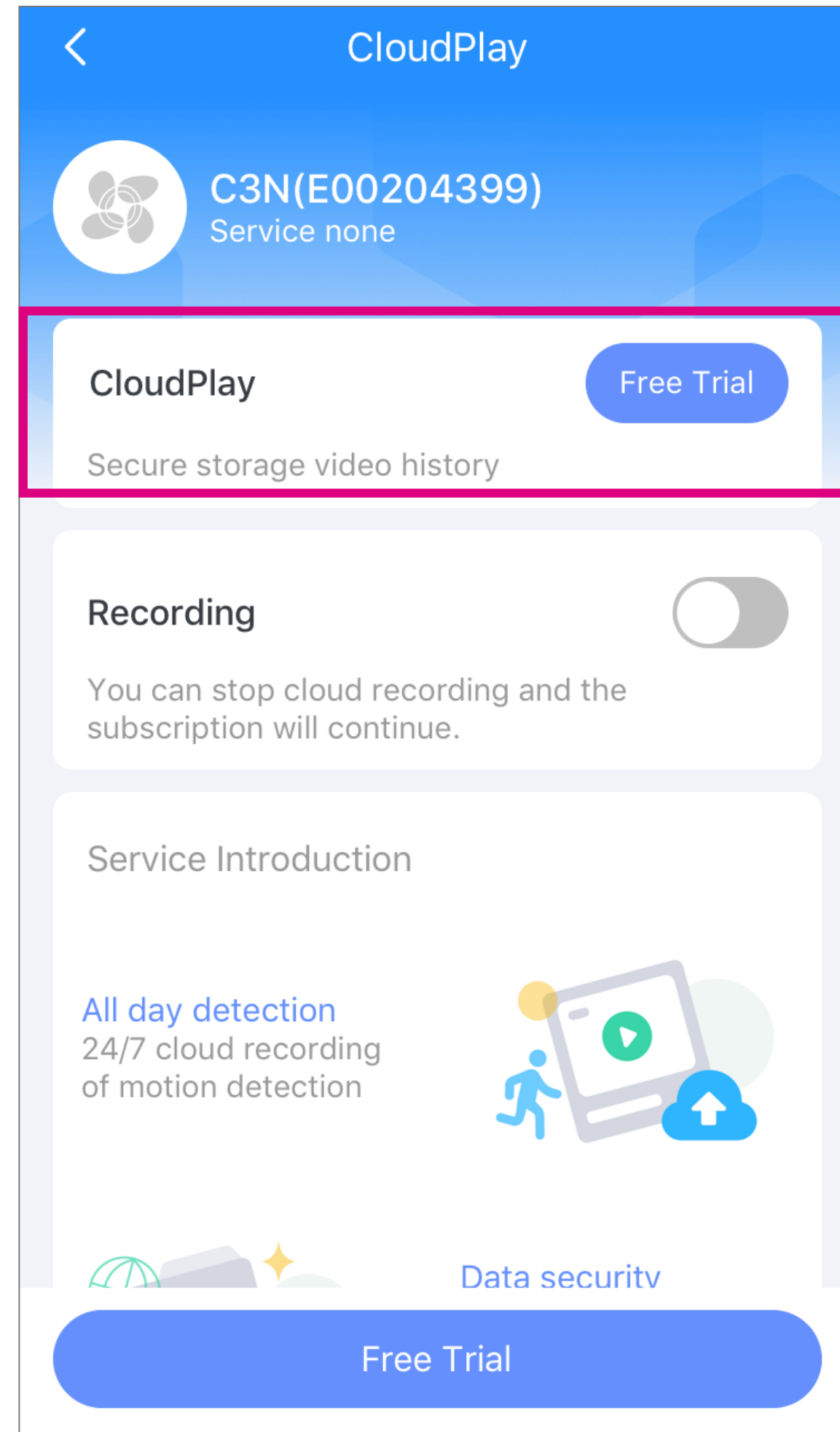
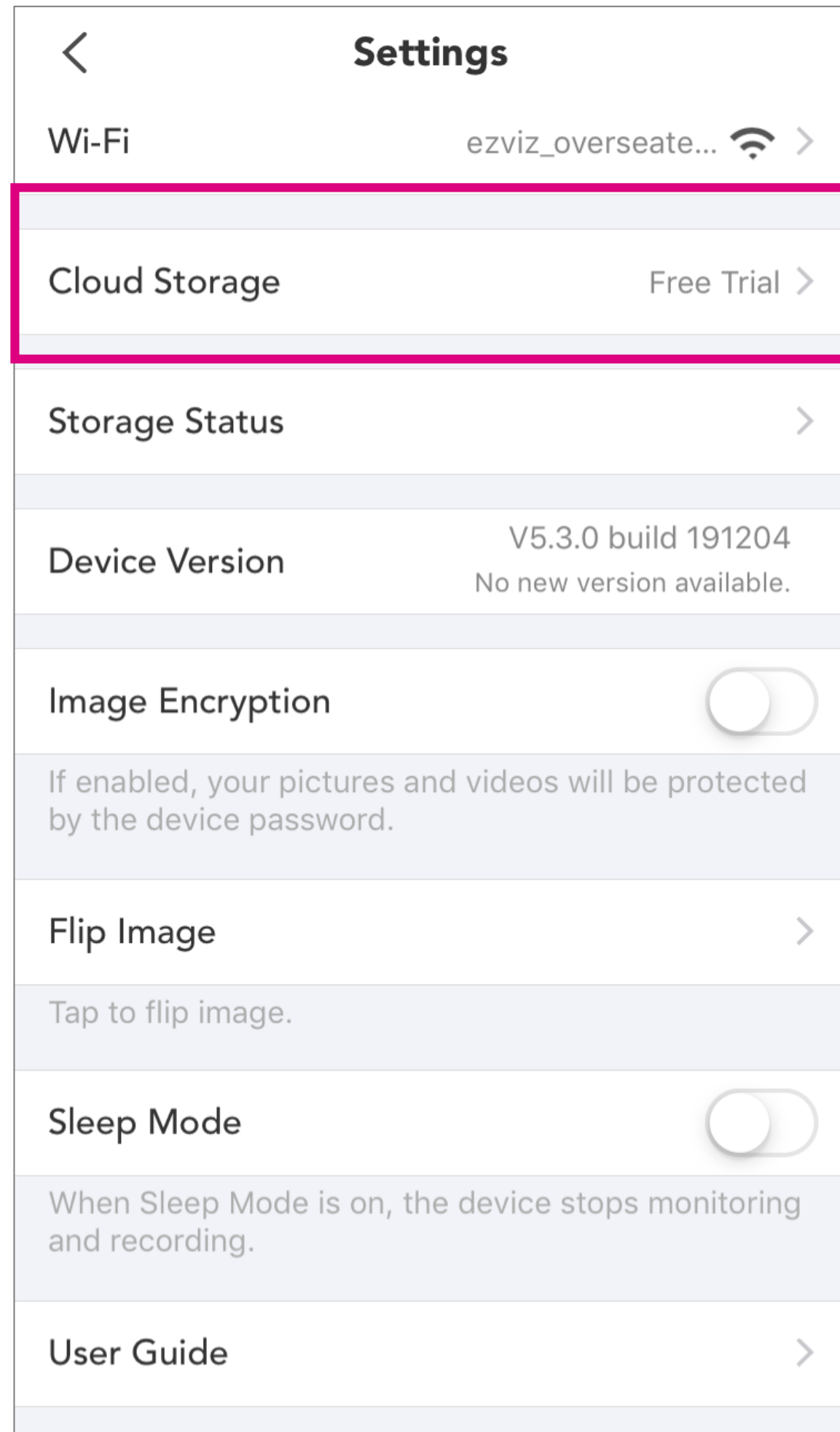

Free 30 Days Trial:
Get free 30-day trial with subscription.

Free 7 Days Trial:
Get free 7-day trial with out subscription.

Price:

7-Day Yearly: € 49.99/ \$ 59.99

7-Day Monthly: € 4.99/ \$ 5.99

30-Day Yearly: € 99.99/ \$ 109.99

30-Day Monthly: € 9.99/ \$ 10.99

APP---Cloud Storage Multiple Speed Playback

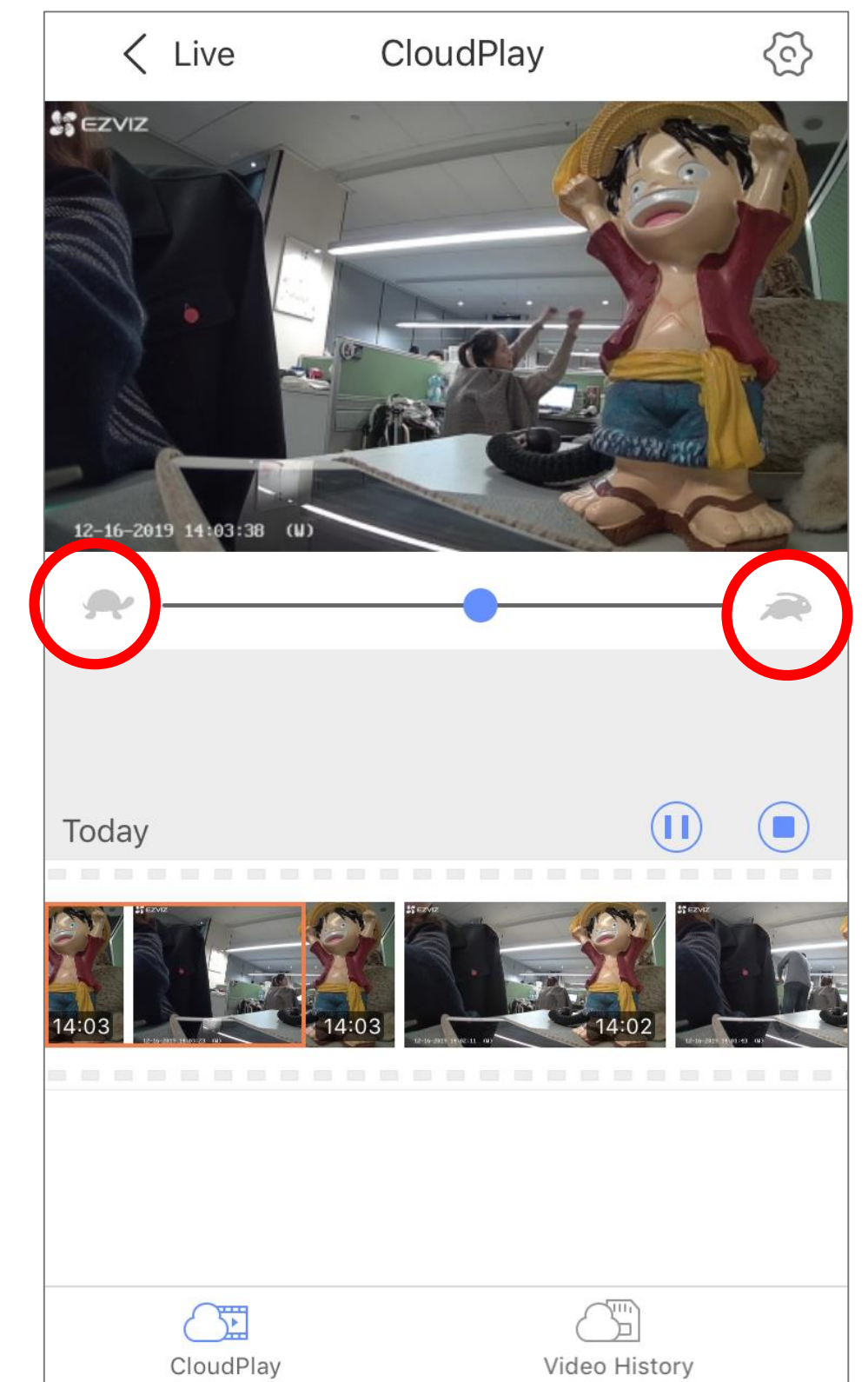
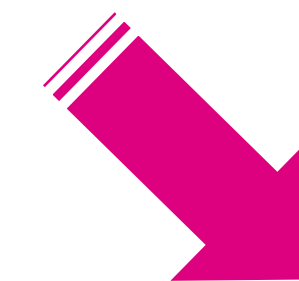
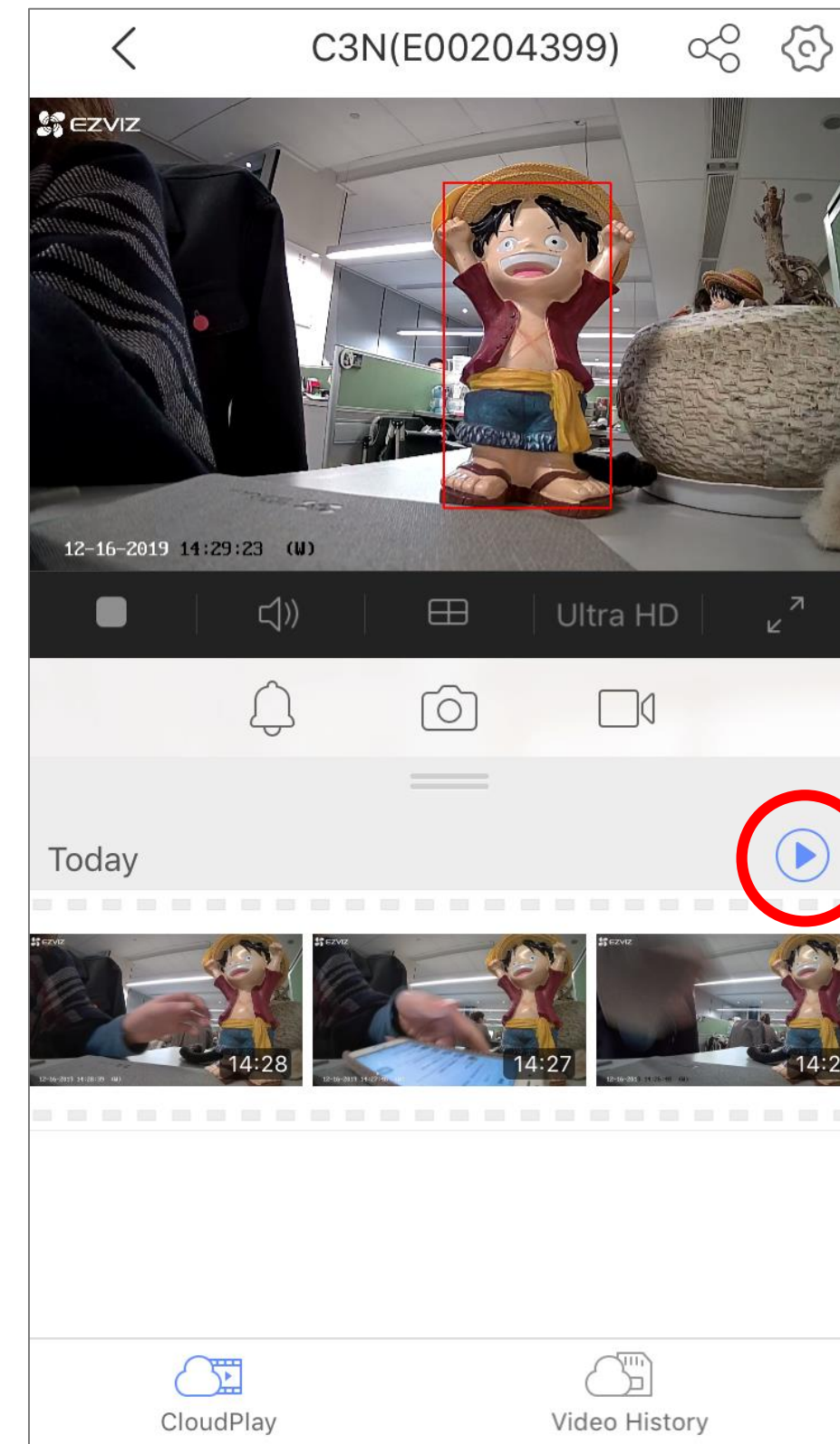
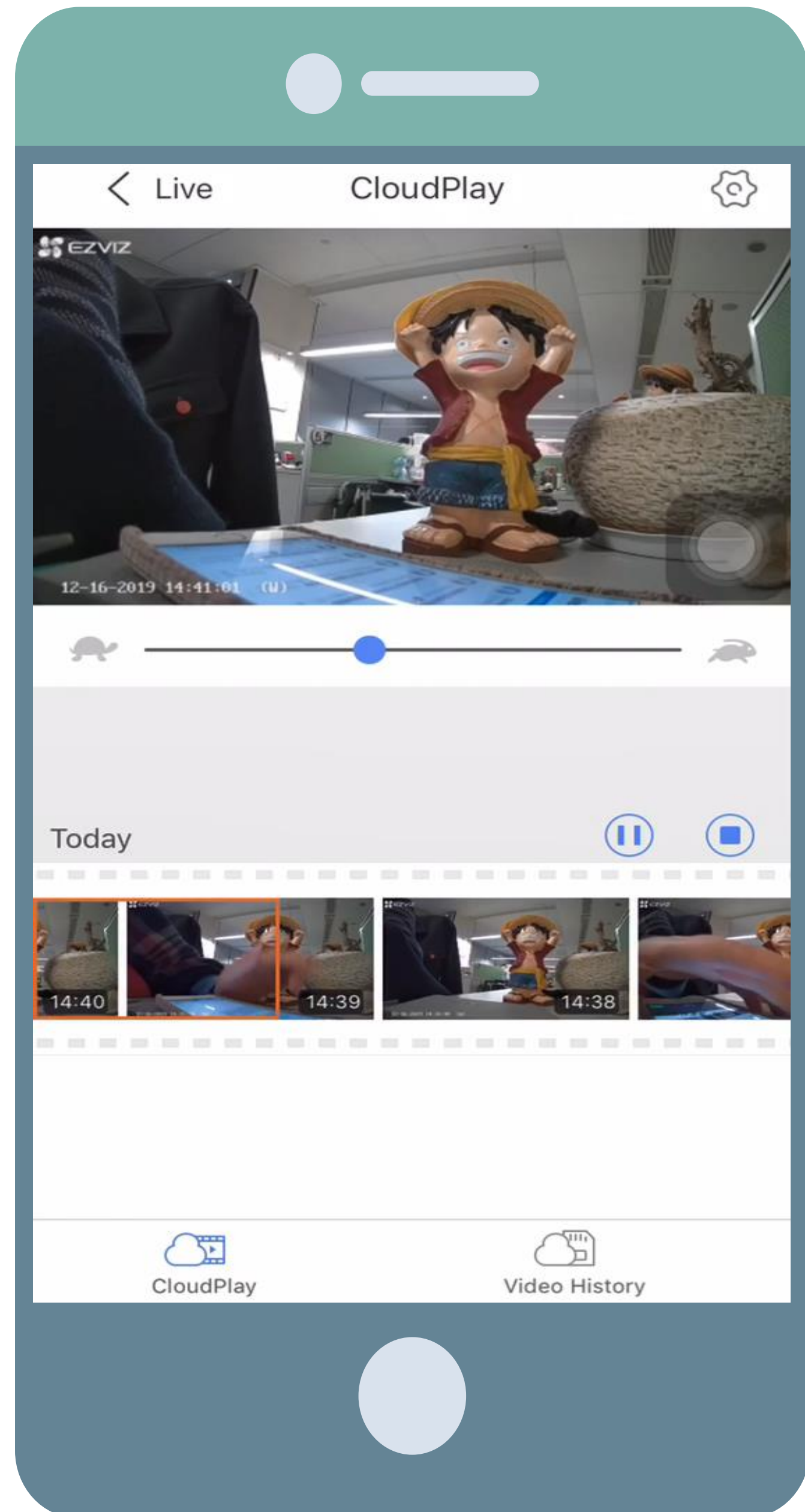

04



FAQ



No.	Question	Answer
1	What is the Max. SD Card that C3N supports?	
2	Where is C3N's reset button?	
3	Does C3N support audio pickup?	
4	Does C3N support audio output?	
5	How could C3N output color night vision?	
6	Please list three different night vision modes of C3N.	
7	Under smart night vision mode, when alarm is triggered only once, how long will the spotlights be on for?	
8	Does C3N support human shape detection?	
9	Explain the function of Intelligent PQ	
10	Does C3N support active sound and light defense?	
11	What is the longest distance for C3N's audio pickup?	
12	Which video compression does C3N support?	
13	What is C3N's water and dust proof grade?	
14	Does C3N support user defined alert tones?	
15	What is the Max. frame rate for C3N?	
16	What is the longest IR distance for C3N?	

Thank You

For more information, visit <https://www.ezvizlife.com/>
Join the EZVIZ communities on Facebook, Instagram, Twitter and YouTube (@ezviz_global)

